

ECOPHON

MASTER™

TAKING CARE OF DEMANDING ACOUSTICS

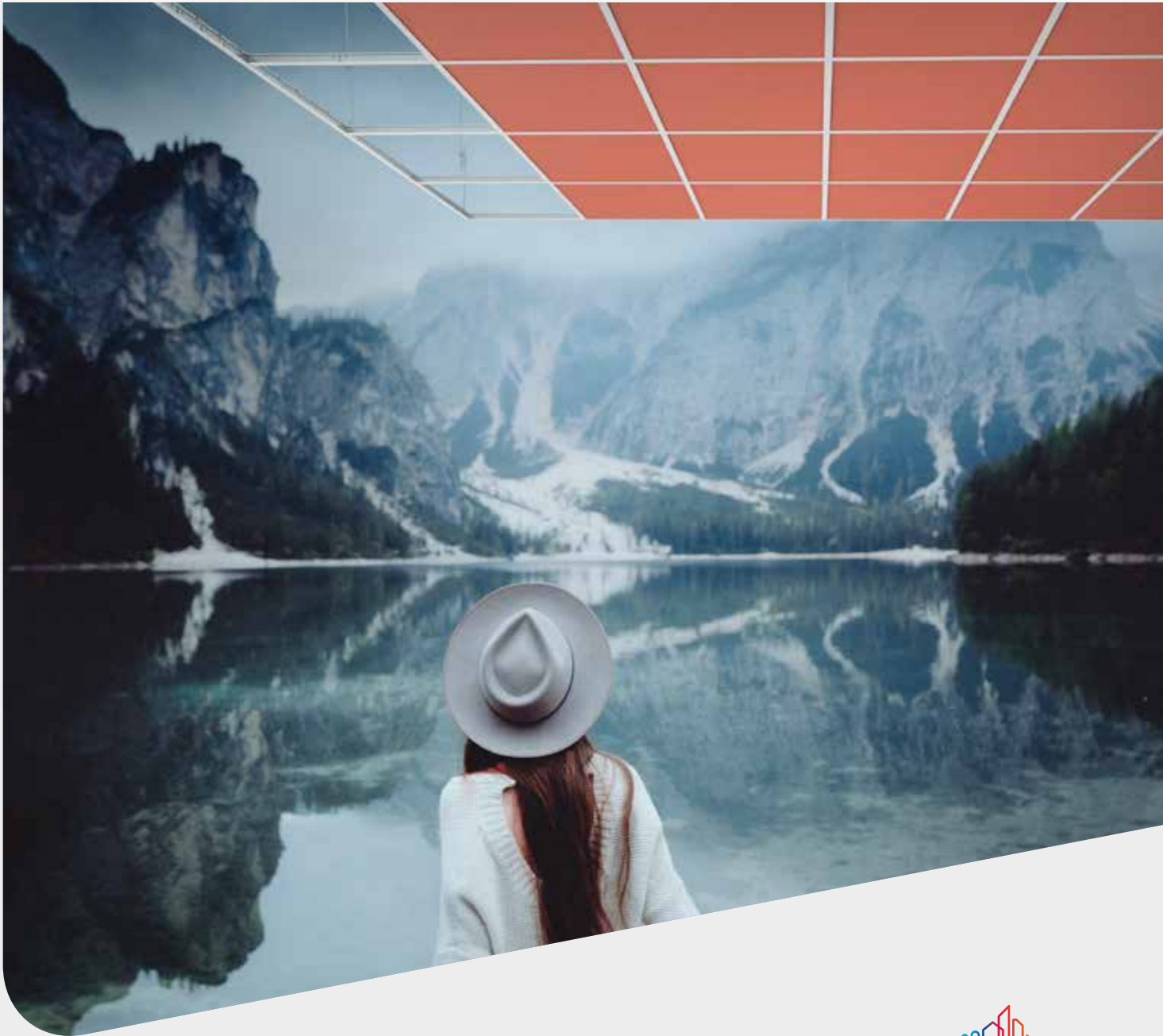

04 ABOUT ECOPHON

06 GOOD ACOUSTICS MATTER EVERYWHERE

08 TOWARDS NET-ZERO ACOUSTICS

10 TAKING CARE OF DEMANDING ACOUSTICS WITH ECOPHON MASTER™

12 ECOPHON MASTER™ PRODUCT RANGE

- 14 Master A
- 14 Master B
- 15 Master Ds
- 15 Master E
- 16 Master Eg
- 17 Master SQ
- 18 Master F
- 18 Master Rigid A
- 19 Master Rigid E
- 19 Master Rigid Dp

20 COLOURS AND SURFACES

22 ECOPHON MASTER™ OVERVIEW

24 SYSTEM PROPERTIES

Acoustics, technical properties and installation diagrams

This publication shows products from Ecophon product range and those of other suppliers. The specifications are intended to provide a general guide to which products are most suitable for the preferences indicated. Technical data is based on results obtained under typical testing conditions or long experience in normal conditions. The specified functions and properties for products and systems are only valid on condition that instructions, installation diagrams, installation guides, maintenance instructions and other stated conditions and recommendations have been taken into consideration and followed. Deviation from this, such as changing specific components or products, will mean that Ecophon cannot be held responsible for the function, consequences and properties of the products. All descriptions, illustrations and dimensions contained in this brochure represent general information and shall not form part of any contract. Ecophon reserves the right to change products without prior notice. We disclaim any liability for misprints. For the latest information go to www.ecophon.com or contact your nearest Ecophon representative.

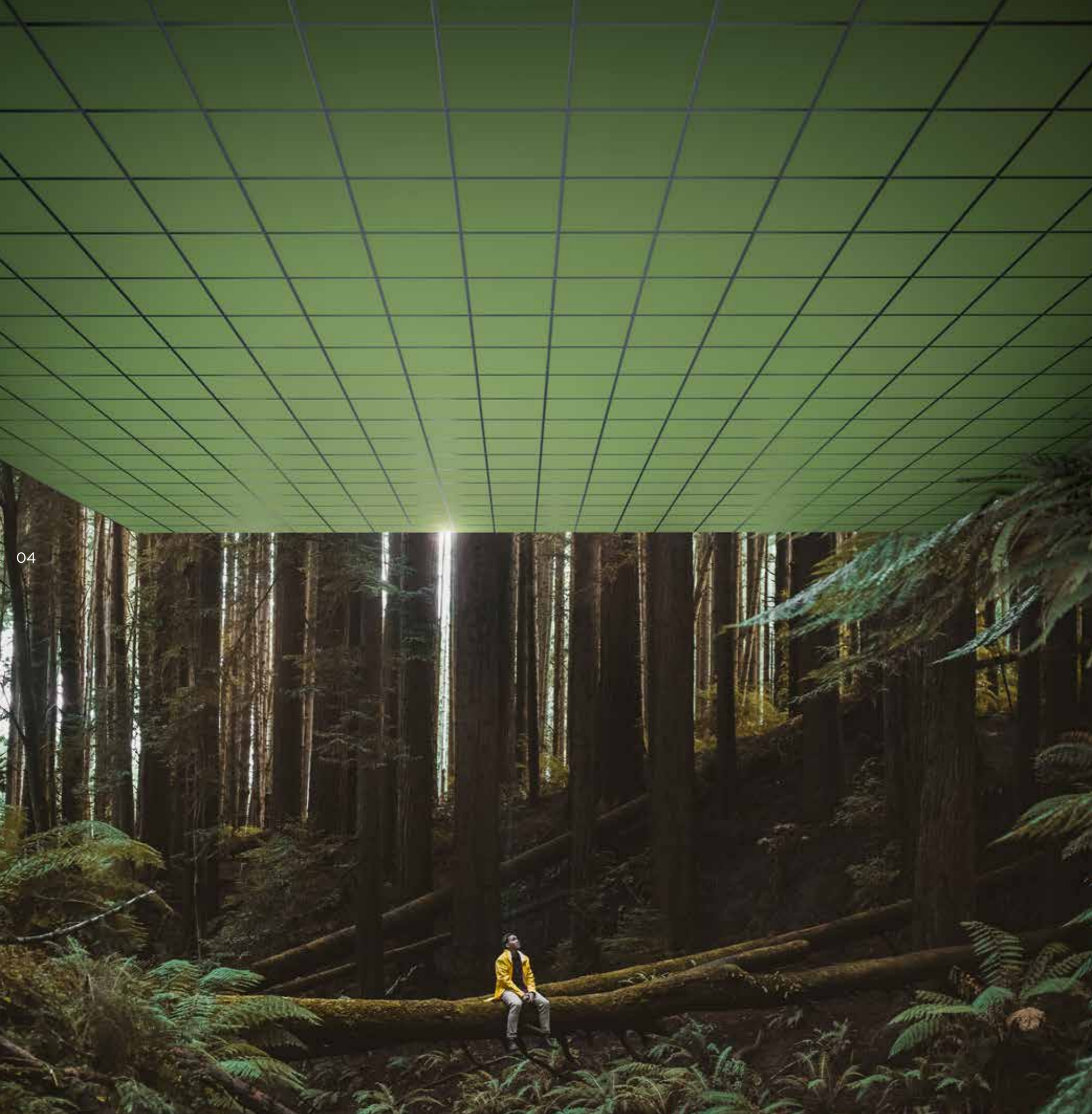

A SOUND EFFECT

ON PEOPLE

Saint-Gobain Ecophon contributes to good indoor environments for working, healing and learning. We do this by developing, manufacturing and delivering acoustic products and systems designed around the natural evolution of human hearing - replicating the outdoor sound experience indoors, because that's just better for people.

Having a sound effect on people, in every way we can, is what we do proudly. That promise makes every one of us a passionate advocate for the importance of room acoustics to people's wellbeing - whatever the space, activity or need.

GOOD ACOUSTICS MATTER EVERYWHERE

06 The importance of acoustics is underappreciated. Sound impacts us in daily life, and the scientific support for improving our indoor sound environments is well-documented.

And what exactly is an ideal indoor sound environment for people? One based on how we experience sound outside. The human auditory sense is naturally adapted to an outdoor environment where there is not any sound reflections from ceilings and walls.

That's why most of what we do at Ecophon is about replicating the acoustic qualities found in nature for indoor environments. We want to optimise indoor spaces to our natural way of hearing, so that speech and sound is easy to hear and understand, when needed, improving performance and wellbeing.

Usually that starts with the ceiling. A wall-to-wall acoustic ceiling is the easiest way to get a large sound-absorbing surface area into a space, and is usually the best way to reduce sound strength, shorten reverberation times, and increase speech clarity and overall hearing comfort.

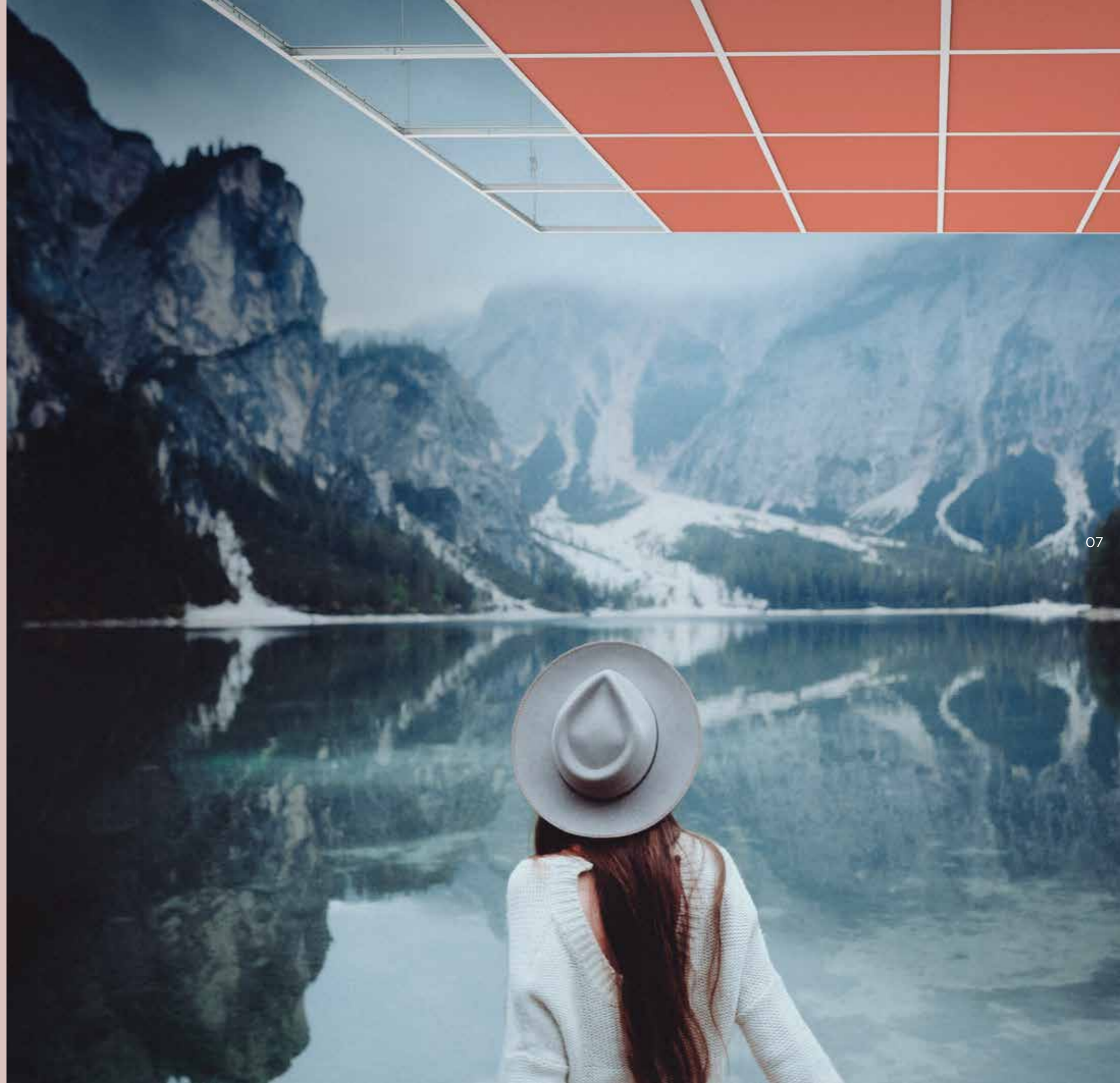



TOWARDS

NET-ZERO ACOUSTICS

Sustainability is more than a word – it’s a collective movement to protect people and the planet that requires honest commitment and genuine care. That’s why Ecophon is building on better materials, transparency, and principles, to name just a few.

We actively support an industry-wide drive to standardised, easy-access Environmental Product Declarations for individual products, rather than product families. Their inclusion of full lifecycle data, from raw material sourcing to end of life, rather than only the favourable stages. A move away from self-declared labels, or non-independently verified sustainability claims. And for any promises of net zero carbon emission targets to be validated by the Science-Based Targets initiative.

If we’re going to build a sustainable future, it has to start with an honest approach, high ambition and the best of intentions – to build on better together.

ECOPHON MASTER™

TAKING CARE OF DEMANDING ACOUSTICS

Ecophon Master™ is at the forefront of acoustic innovation and unrivalled in meeting acoustically challenging environments. The result provides excellent sound absorption and speech intelligibility.

- Absorption class A
- Offers 2 different product systems with 8 different edges
- Premium surface with matte look

Spaces where phones are used frequently, or where other high ambient noise levels are to be expected, can be hard to concentrate, be productive or learn in. Master suspended ceiling systems provide exceptional sound absorption and speech clarity – perfect for busy offices, classrooms, or anywhere speech intelligibility is the priority.

Minimum

59%

POST-CONSUMER
RECYCLED CONTENT



Industry-low

CO₂ EMISSIONS

with exceptional raw material and wide use of renewable energies

ECOPHON MASTER™ PRODUCT RANGE

Master offer suspended wall-to-wall ceilings with excellent acoustic properties and direct fixing solutions with screws or glue adhesive for a quick and easy acoustic upgrade.

Patent-pending Master Eg is a unique system offering design possibilities with a floating appearance.

Master Rigid systems have a reinforced, durable and impact-resistant surface and is secured in the grid system. Combine with Ecophon Extra Bass for extra low-frequency absorption

MASTER Eg

- 600x600
- 1200x600
- 1200x1200
- 2400x600



MASTER F

- 600x600x40
- 1200x600x40



MASTER SQ

- 600x600x40
- 1200x600x40



MASTER RIGID A

- 600x600x40
- 1200x600x40
- 1600x600x20
- 1800x600x20
- 2000x600x20
- 2400x600x20



MASTER RIGID E

- 600x600x20
- 1200x600x20
- 1200x1200x20



MASTER RIGID Dp

- 600x600x20
- 1200x600x20



MASTER A

- 600x600x40
- 1200x600x40
- 1200x1200x40



MASTER B

- 600x600x40
- 1200x600x40



MASTER Ds

- 600x600x40



MASTER E

- 600x600x40
- 1200x600x40
- 1200x1200x40





MASTER A

Visible grid system and easy demountable tiles. Available in many formats

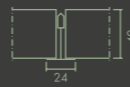

MASTER Ds

Bevelled edges that generates a discreet groove between the tiles. Concealed grid system.

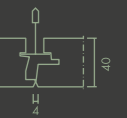

MASTER B

For direct fixing with glue. Ideal for installations that require minimum depth of system.

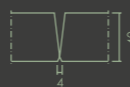

MASTER E

Recessed visible grid system creating a shadow effect on the edge. Easily demountable tiles.

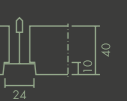



MASTER Eg
 Unique edge design painted in two colours with concealed support edges and a floating appearance.

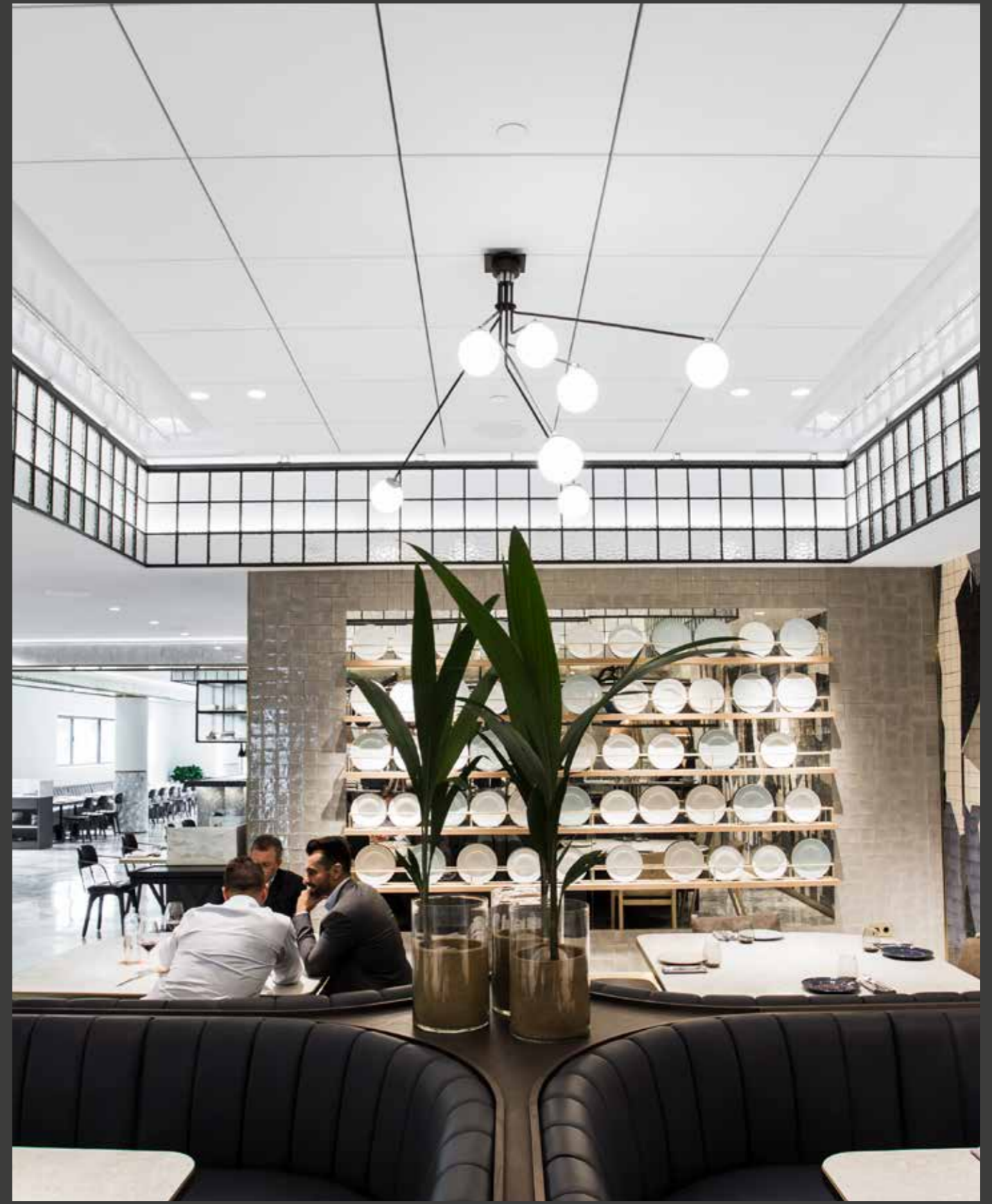
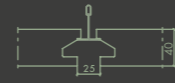

MASTER SQ
 For direct fixing with glue. Installed with a gap between each tile.

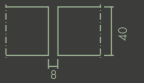



MASTER F

For direct fixing with screws. Ideal for installations that require minimum depth of system.



MASTER RIGID E

Recessed visible grid system creating a shadow effect on the edge. Reinforced surface secured by clips but fully demountable tiles.



MASTER RIGID A

Visible grid system with reinforced surface secured by clips but fully demountable tiles. Available in many formats.



MASTER RIGID Dp

A patented semi-concealed system. Reinforced surface secured by clips but fully demountable tiles.

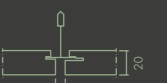

GRID COLOURS - CREATE YOUR OWN DESIGN

An acoustic ceiling is often the largest continuous surface in a room. It will affect not only the entire look and feel of the interior, but also the end-users' wellbeing.

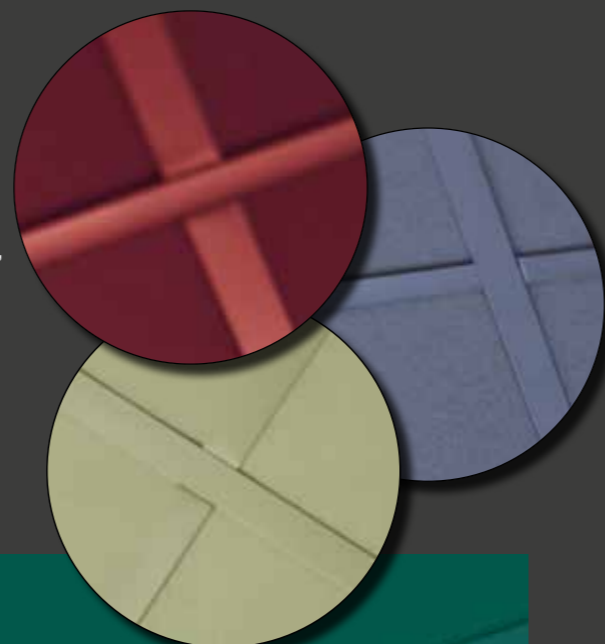

- 15 colour options for grids
- Closest Akutex FT match creates subtile pattern and mixing FT colours gives more design effect

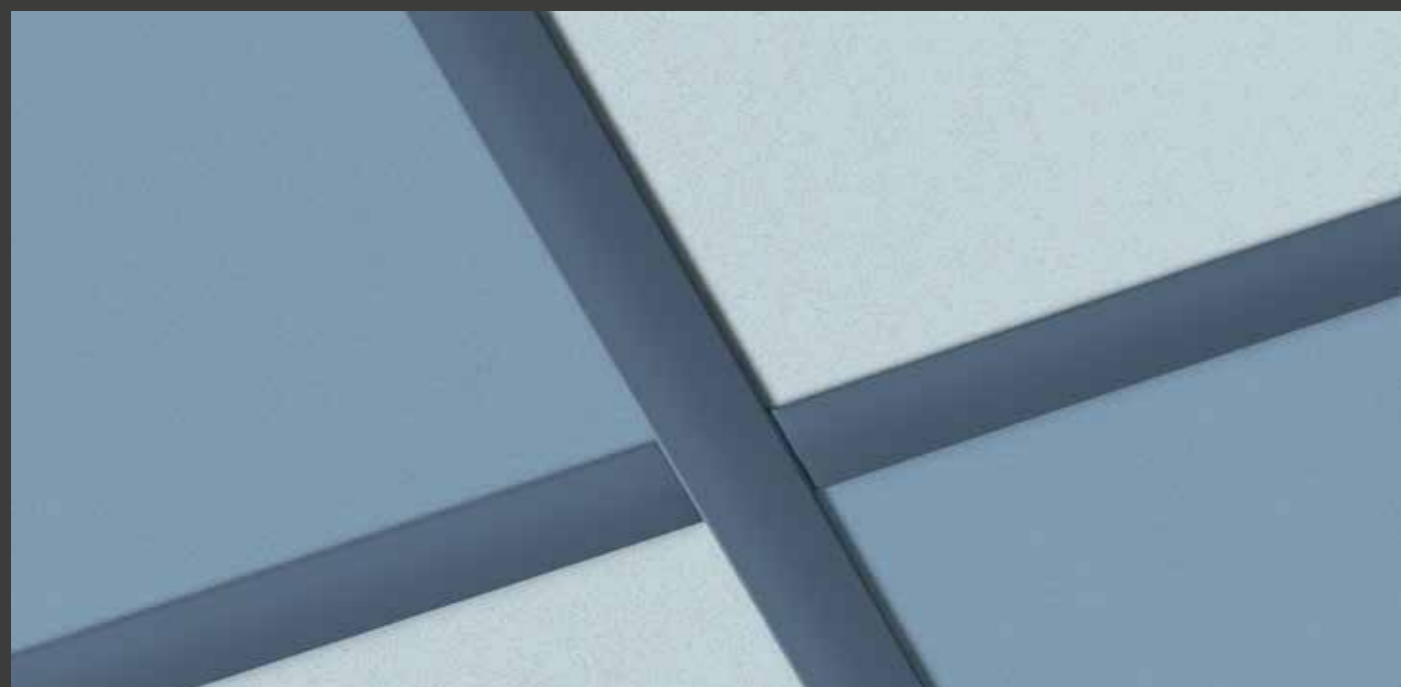

COLOURS AND SURFACES

AKUTEX™ FT

The Akutex label guarantees that the product carrying it has a superior surface technology. Our research and development will always focus on visual aspects, acoustic properties, working environment, architectural trends and environmental aspects. This ensures that Akutex is always one step ahead.



WHITE FROST
Nearest NCS colour sample S 0500-N.
Light reflectance 85%.



OCEAN STORM
Nearest NCS colour sample S 4020-R90B.
Light reflectance 24%.



MORNING DRIZZLE
Nearest NCS colour sample S 1002-B.
Light reflectance 69%.



VOLCANIC ASH
Nearest NCS colour sample 2002-Y.
Light reflectance 56%.



MOONLIGHT SKY
Nearest NCS colour sample S 7020-R90B.
Light reflectance 7%.



CLOUDY DAY
Nearest NCS colour sample S 1500-N.
Light reflectance 62%.



SILVER STONE
Nearest NCS colour sample S 4502-Y.
Light reflectance 29%.



GOLDEN FIELD
Nearest NCS colour sample S 1040-G90Y.
Light reflectance 61%.



PEACH ROSE
Nearest NCS colour sample S 1515-Y80R.
Light reflectance 55%.

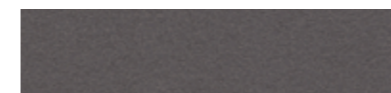

SILK SLATE
Nearest NCS colour sample S 7000-N.
Light reflectance 13%.



SUNSET HEAT
Nearest NCS colour sample S 2070-Y60R.
Light reflectance 20%.



HIGHLAND FOG
Nearest NCS colour sample S 2005-G.
Light reflectance 55%.



GOJI BERRY
Nearest NCS colour sample S 3030-Y80R.
Light reflectance 27%.



RUBY ROCK
Nearest NCS colour sample S 4050-R10B.
Light reflectance 7%.



SAGE GARDEN
Nearest NCS colour sample S 3010-B30G.
Light reflectance 40%.



SILENT STEAM
Nearest NCS colour sample S 2010-B.
Light reflectance 45%.



EUCALYPTUS LEAF
Nearest NCS colour sample S 5010-B30G.
Light reflectance 23%.



FRESH CLOVER
Nearest NCS colour sample S 3020-G40Y.
Light reflectance 35%.



SCALLOP SHELLS
Nearest NCS colour sample S 0804-Y50R.
Light reflectance 76%.



SUMMER FOREST
Nearest NCS colour sample S 6030-G10Y.
Light reflectance 10%.



WET SAND
Nearest NCS colour sample S 3020-Y30R.
Light reflectance 35%.



DARK DIAMOND
Nearest NCS colour sample S 9000-N.
Light reflectance 4%.

NOTE
Colours may vary slightly between different production batches.
Reproduction of colours vary between print and reality.

ECOPHON MASTER OVERVIEW

EDGE DESIGN	PRODUCT	ABSORPTION CLASS	CONNECT GRID	SIZES(MM)	POSSIBLE COMBINATIONS
	Ecophon Master A	A	T15 / T24	600x600x40 1200x600x40 1200x1200x40	
	Ecophon Master B	A	Direct fixing	600x600x40 1200x600x40	
	Ecophon Master Ds	A	T24	600x600x40	
	Ecophon Master E	A	T24	600x600x40 1200x600x40 1200x1200x40	
	Ecophon Master Eg	A	T24	600x600 1200x600 1200x1200 2400x600	
	Ecophon Master F	A	Direct fixing	600x600x40 1200x600x40	
	Ecophon Master SQ	A	Direct fixing	600x600x40 1200x600x40	
	Ecophon Master Rigid A	A	T24	600x600x20 1200x600x20 1600x600x20 1800x600x20 2000x600x20 2400x600x20	Extra Bass 1200x600
	Ecophon Master Rigid E	A	T24	600x600x20 1200x600x20 1200x1200x20	Extra Bass 1200x600
	Ecophon Master Rigid Dp	A	T24	600x600x20 1200x600x20	Extra Bass 1200x600



Ecophon Master panels contribute to a healthy indoor environment with superior acoustic absorption, low VOC emissions in line with the strictest requirements, and a full chemical transparency with verified Health Product Declarations. The low environmental footprint of our Master panels is third-party verified in Environmental Product Declarations.



For projects where environmental excellence is a priority, Ecophon offers you the Plant option, specifically designed to maximise the contribution of the ceiling to green building certification schemes. Our Plant panel range features bio-based materials, an industry-low CO₂ footprint and the lowest indoor air emissions, with the Eurofins Indoor Air Comfort Gold certification.

The products do not contribute to fire and the glass wool core of the Master tiles is tested and classified as non-combustible according to EN ISO 1182. Fire classification according to EN 13501-1, see Technical Properties on respectively product.

NOTE
More product and system information such as installation help and sustainability documentation can be found at www.ecophon.com



Ecophon Master A Ecophon Master B Ecophon Master Ds Ecophon Master E Ecophon Master Eg Ecophon Master F Ecophon Master SQ



Ecophon Master Rigid A Ecophon Master Rigid E Ecophon Master Rigid Dp

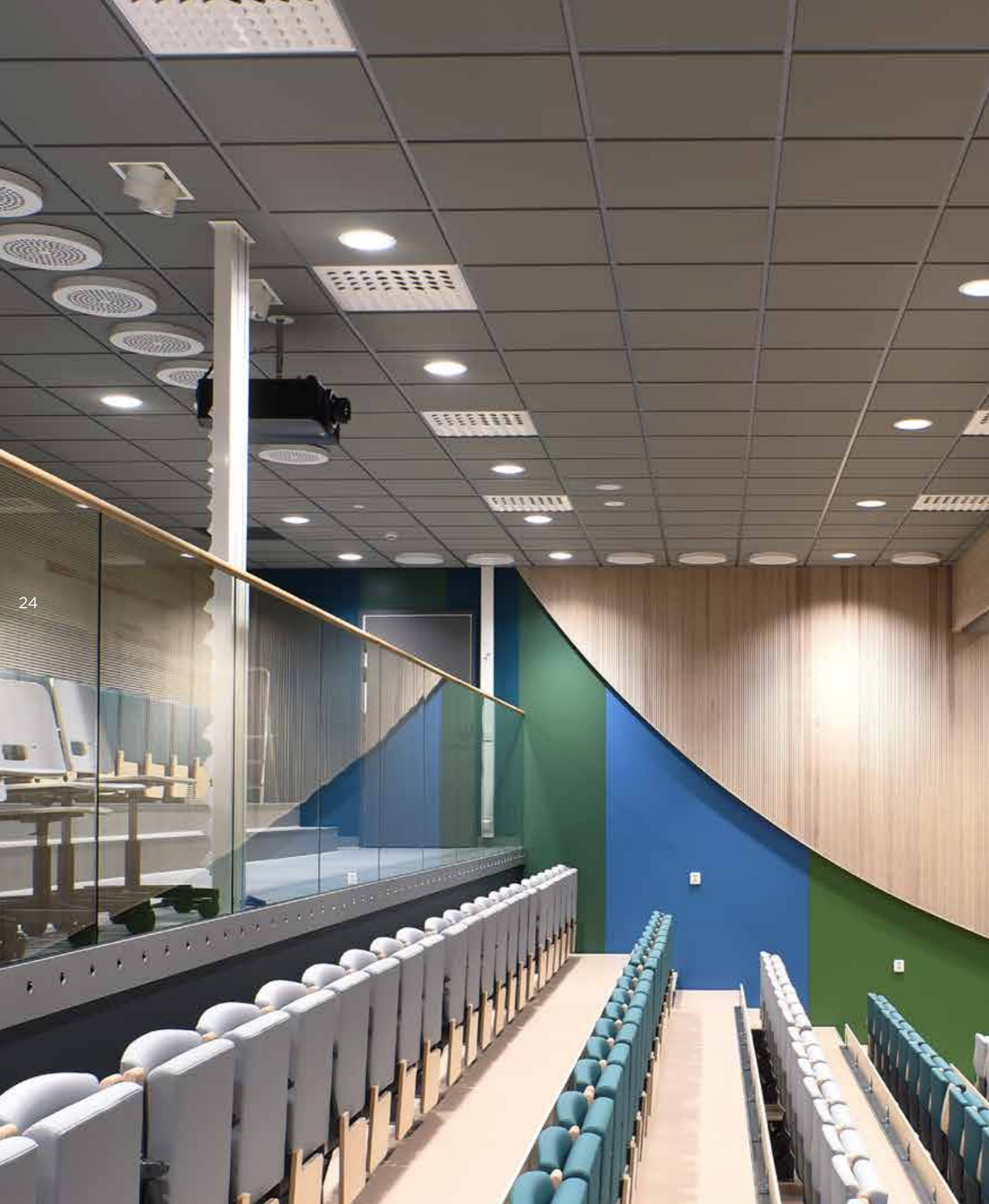

SYSTEM PROPERTIES

ACOUSTICS, TECHNICAL PROPERTIES AND INSTALLATION DIAGRAMS

- 26 Master A
- 28 Master B
- 30 Master Ds
- 32 Master E
- 34 Master Eg
- 36 Master SQ
- 38 Master F
- 40 Master Rigid A
- 42 Master Rigid E
- 44 Master Rigid Dp

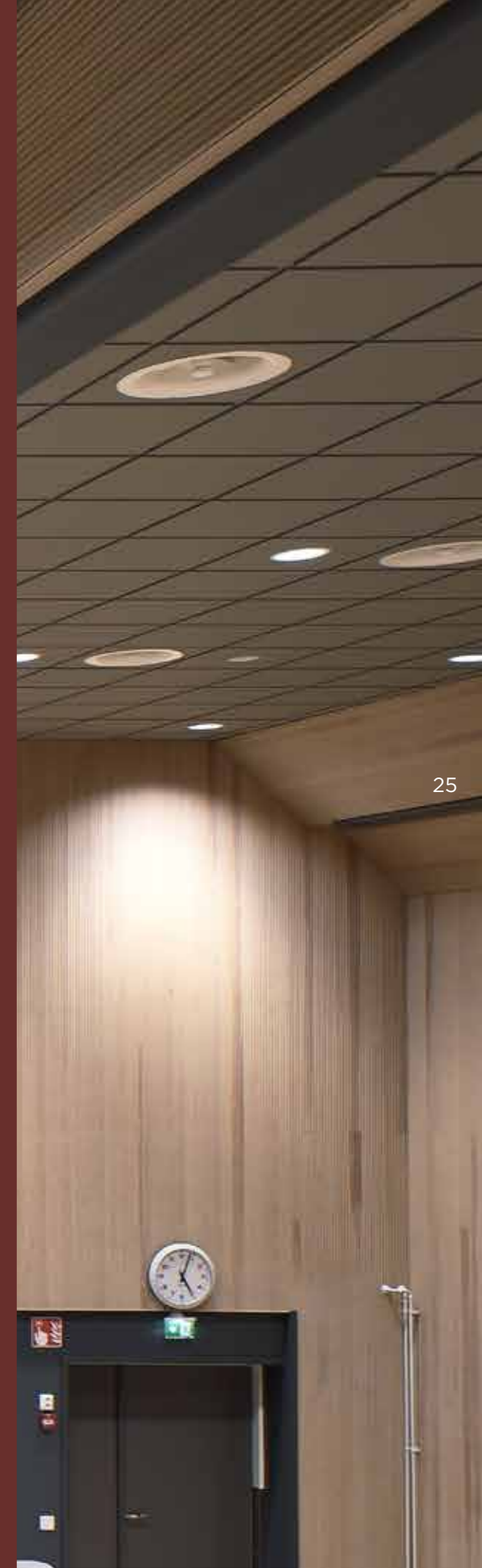

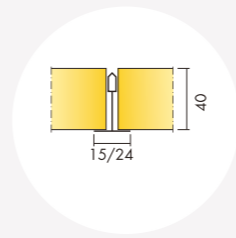

Ecophon Master™ A

Acoustic:

Sound Absorption:

Test results according to EN ISO 354. Classification according to EN ISO 11654, and the single value ratings for Noise Reduction Coefficient, NRC and Sound Absorption Average, SAA according to ASTM C 423.

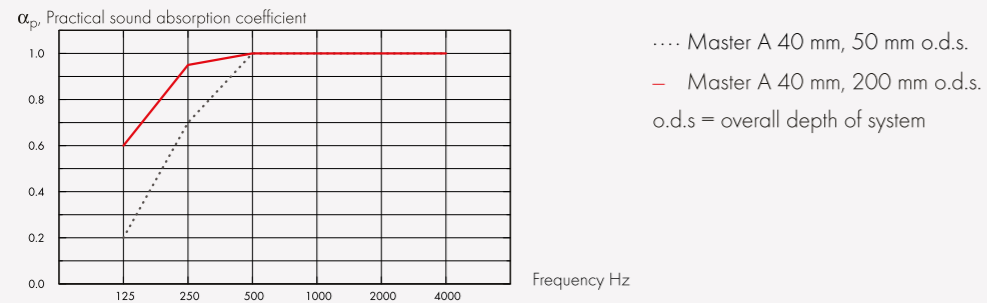

THK mm	o.d.s. mm	α_p , Practical sound absorption coefficient						α_w	Sound absorption class
		125 Hz	250 Hz	500 Hz	1000 Hz	2000 Hz	4000 Hz		
40	50	0.20	0.70	1.00	1.00	1.00	1.00	1.00	A
40	200	0.60	0.95	1.00	1.00	1.00	1.00	1.00	A

	THK mm	o.d.s. mm	NRC	SAA
-	40	50	1.00	1.00
-	40	400	0.95	0.93

THK mm	AC(1.5)		D_{nfw}	CAC dB
	Articulation Class, ASTM E1111, ASTM E1110			
40	200		28	30

Indoor Air Quality:

Certificate / Label	Plant
Eurofins Indoor Air Comfort®	IAC IAC Gold
French VOC	A A+
Finnish M1	• •

Environmental Footprint: Life-cycle stages A1 to C4 from EPD, in conformity with ISO 14025 / EN 15804

	kg CO ₂ equiv/m ²
Master A	3,70
Master A/Plant	3,09

Circularity: Minimum post-consumer recycled content: 59%, Recyclability: Fully recyclable,

Fire safety: The glass wool core of the tiles is tested and classified as non-combustible according to EN ISO 1182. Europe: EN 13501-1, A2-s1,d0,

Humidity Resistance: According to EN 13964:2014 Standard: Class C, RH 95% and 30°C, Plant: Class A, RH 70% and 25°C,

Visual appearance: White Frost, nearest NCS colour sample S 0500-N, 85% light reflectance. Gloss < 1.

Cleanability: Daily dusting and vacuum cleaning. Weekly wet wiping.

Accessibility: The tiles are easily demountable. Minimum demounting depth according to installation diagrams.

Installation: Installed according to installation diagrams, installation guides and drawing aid. For information regarding minimum overall depth of system see quantity specification.

System weight: The weight of the system (including suspension grid) should be approximately 5 kg/m².

Mechanical properties: See table about Max live load and Min load bearing capacity and Functional demands, Mechanical properties at www.ecophon.com.

CE: Ecophon ceiling systems are CE marked according to the European harmonized standard EN13964:2014. CE marked construction products are covered by a Declaration of Performance (DOP) which enables customers and users to easily compare performance of products available on the European market.

Installation diagram in detail www.ecophon.com

M56

Installation diagram (M56) for Ecophon Master A

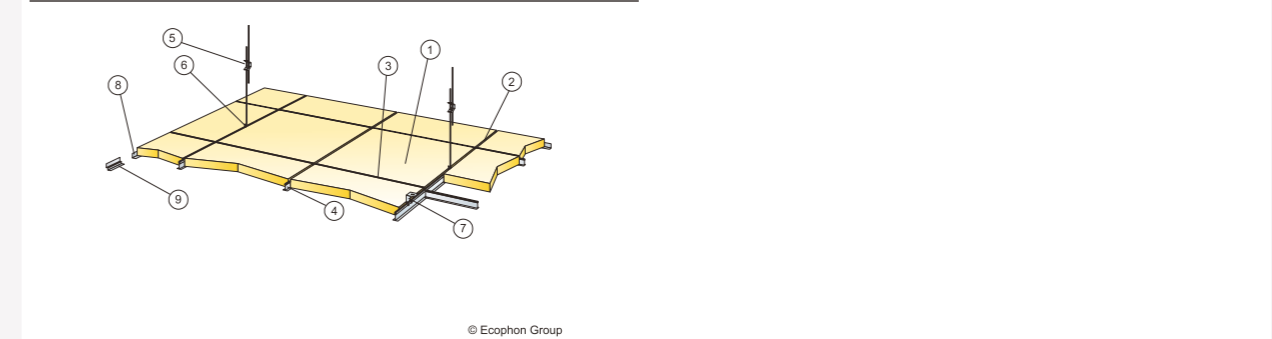

© Ecophon Group

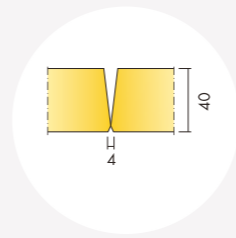

Ecophon Master™ B

Acoustic:

Sound Absorption:

Test results according to EN ISO 354. Classification according to EN ISO 11654, and the single value ratings for Noise Reduction Coefficient, NRC and Sound Absorption Average, SAA according to ASTM C 423.

α_p , Practical sound absorption coefficient

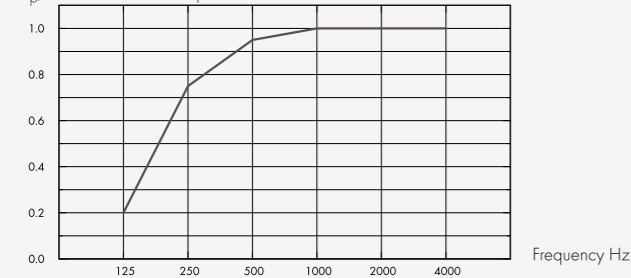

— Master B 40 mm, 43 mm o.d.s.
o.d.s = overall depth of system

THK mm	o.d.s. mm	α_p , Practical sound absorption coefficient						α_w	Sound absorption class
		125 Hz	250 Hz	500 Hz	1000 Hz	2000 Hz	4000 Hz		
40	43	0.20	0.75	0.95	1.00	1.00	1.00	1.00	A

	THK mm	o.d.s. mm	NRC	SAA
-	40	43	0.95	0.93

Indoor Air Quality:

Certificate / Label

Eurofins Indoor Air Comfort®	IAC
French VOC	A
Finnish M1	•

Environmental Footprint: Life-cycle stages A1 to C4 from EPD, in conformity with ISO 14025 / EN 15804

	kg CO ₂ equiv/m ²
Master B	7,30

Circularity: Minimum post-consumer recycled content: 62%, Recyclability: Fully recyclable,

Fire safety: The glass wool core of the tiles is tested and classified as non-combustible according to EN ISO 1182. Europe: EN 13501-1, A2-s1,d0,

Humidity Resistance: Class C, relative humidity 95% and 30°C, according to EN 13964:2014

Visual appearance: White Frost, nearest NCS colour sample S 0500-N, 85% light reflectance. Gloss < 1.

Cleanability: Daily dusting and vacuum cleaning. Weekly wet wiping.

Accessibility: The tiles are not demountable.

Installation: Installed according to installation diagrams, installation guides and drawing aid. For information regarding minimum overall depth of system see quantity specification. Rendered surfaces must have sufficient strength to be able to carry the load imposed by the tiles. If doubts, test gluing should be carried out. The surface should always be dry and clean. For best result the surface should be even.

System weight: The weight of the system should be approximately 5 kg/m².

Mechanical properties: Additional live load has to be fixed to the soffit.

CE: Ecophon ceiling systems are CE marked according to the European harmonized standard EN13964:2014. CE marked construction products are covered by a Declaration of Performance (DOP) which enables customers and users to easily compare performance of products available on the European market.

Installation diagram in detail www.ecophon.com

M113

Installation diagram (M113) for Ecophon Master B, using Connect Absorber glue

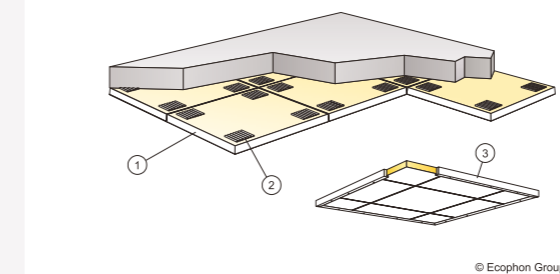

© Ecophon Group

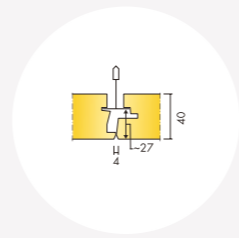

Ecophon Master™ Ds

Acoustic:

Sound Absorption:

Test results according to EN ISO 354. Classification according to EN ISO 11654, and the single value ratings for Noise Reduction Coefficient, NRC and Sound Absorption Average, SAA according to ASTM C 423.

α_p , Practical sound absorption coefficient

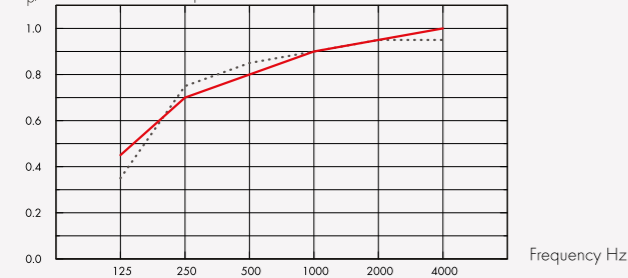

..... Master Ds 40 mm, 95 mm o.d.s.
 — Master Ds 40 mm, 200 mm o.d.s.
 o.d.s = overall depth of system

THK mm	o.d.s. mm	α_p , Practical sound absorption coefficient						α_w	Sound absorption class
		125 Hz	250 Hz	500 Hz	1000 Hz	2000 Hz	4000 Hz		
40	95	0.35	0.75	0.85	0.90	0.95	0.95	0.90	A
40	200	0.45	0.70	0.80	0.90	0.95	1.00	0.90	A

	THK mm	o.d.s. mm	NRC	SAA
-	40	95	0.90	0.91
-	40	400	0.85	0.86

THK mm	AC(1.5)		D_{nfw}	CAC dB
	Articulation Class, ASTM E1111, ASTM E1110			
40	200		31	33

Indoor Air Quality:

Certificate / Label

Eurofins Indoor Air Comfort®	IAC
French VOC	A
Finnish M1	•

Environmental Footprint: Life-cycle stages A1 to C4 from EPD, in conformity with ISO 14025 / EN 15804

	kg CO ₂ equiv/m ²
Master Ds	7,10

Circularity: Minimum post-consumer recycled content: 63%, Recyclability: Fully recyclable,

Fire safety: The glass wool core of the tiles is tested and classified as non-combustible according to EN ISO 1182. Europe: EN 13501-1, A2-s1,d0,

Humidity Resistance: Class C, relative humidity 95% and 30°C, according to EN 13964:2014

Visual appearance: White Frost, nearest NCS colour sample S 0500-N, 85% light reflectance. Gloss < 1.

Cleanability: Daily dusting and vacuum cleaning. Weekly wet wiping.

Accessibility: The tiles are easily demountable. Minimum demounting depth according to installation diagrams.

Installation: Installed according to installation diagrams, installation guides and drawing aid. For information regarding minimum overall depth of system see quantity specification. The systems are not recommended for small rooms (approximately 2x2 m²). Ceilings with a large amount of integrations require careful planning, design and installation.

System weight: The weight of the system (including suspension grid) should be approximately 6 kg/m².

Mechanical properties: See table about Max live load and Min load bearing capacity and Functional demands, Mechanical properties at www.ecophon.com.

CE: Ecophon ceiling systems are CE marked according to the European harmonized standard EN13964:2014. CE marked construction products are covered by a Declaration of Performance (DOP) which enables customers and users to easily compare performance of products available on the European market.

Installation diagram in detail www.ecophon.com

M236

Installation diagram (M236) for Ecophon Master Ds, suspended installation

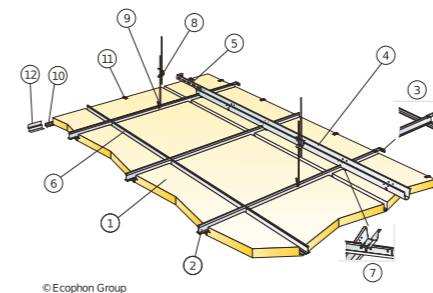

M242

Installation diagram (M242) for Ecophon Master Ds, direct installation

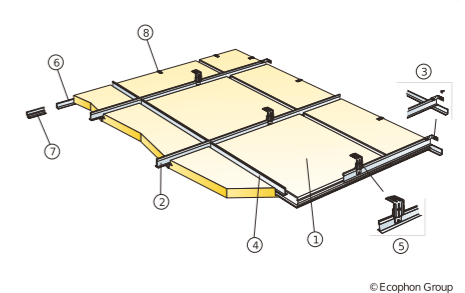

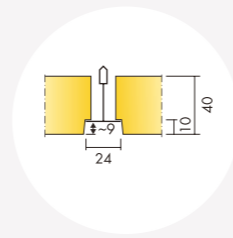

Ecophon Master™ E

Acoustic:

Sound Absorption:

Test results according to EN ISO 354. Classification according to EN ISO 11654, and the single value ratings for Noise Reduction Coefficient, NRC and Sound Absorption Average, SAA according to ASTM C 423.

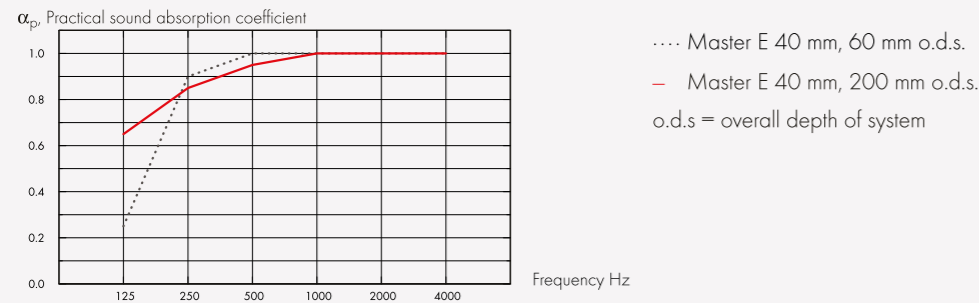

THK mm	o.d.s. mm	α_p , Practical sound absorption coefficient						α_w	Sound absorption class
		125 Hz	250 Hz	500 Hz	1000 Hz	2000 Hz	4000 Hz		
40	60	0.25	0.90	1.00	1.00	1.00	1.00	1.00	A
40	200	0.65	0.85	0.95	1.00	1.00	1.00	1.00	A

THK mm	o.d.s. mm	NRC	SAA
-	40	1.00	0.98
-	40	0.95	0.97
-	40	0.90	0.89

THK mm	AC(1.5) Articulation Class, ASTM E1111, ASTM E1110	D_{nfw} Weighted normalized flanking level difference, ISO 10848-2	CAC dB Ceiling Attenuation Class, ASTM 1414, ASTM E413
40	200	29	31

Indoor Air Quality:

Certificate / Label	Plant
Eurofins Indoor Air Comfort®	IAC IAC Gold
French VOC	A A+
Finnish M1	• •

Environmental Footprint: Life-cycle stages A1 to C4 from EPD, in conformity with ISO 14025 / EN 15804

	kg CO ₂ equiv/m ²
Master E	6,10
Master E/Plant	4,15

Circularity: Minimum post-consumer recycled content: 61%, Recyclability: Fully recyclable,

Fire safety: The glass wool core of the tiles is tested and classified as non-combustible according to EN ISO 1182. Europe: EN 13501-1, A2-s1,d0,

Humidity Resistance: According to EN 13964:2014 Standard: Class C, RH 95% and 30°C, Plant: Class A, RH 70% and 25°C,

Visual appearance: White Frost, nearest NCS colour sample S 0500-N, 85% light reflectance. Gloss < 1.

Cleanability: Daily dusting and vacuum cleaning. Weekly wet wiping.

Accessibility: The tiles are easily demountable. Minimum demounting depth according to installation diagrams.

Installation: Installed according to installation diagrams, installation guides and drawing aid. For information regarding minimum overall depth of system see quantity specification.

System weight: The weight of the system (including suspension grid) should be approximately 5 kg/m².

Mechanical properties: See table about Max live load and Min load bearing capacity and Functional demands, Mechanical properties at www.ecophon.com.

CE: Ecophon ceiling systems are CE marked according to the European harmonized standard EN13964:2014. CE marked construction products are covered by a Declaration of Performance (DOP) which enables customers and users to easily compare performance of products available on the European market.

Installation diagram in detail www.ecophon.com

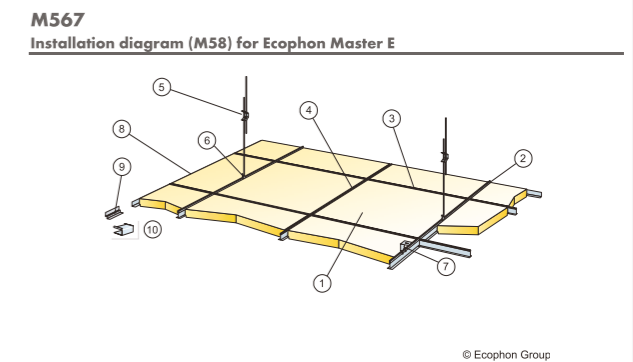
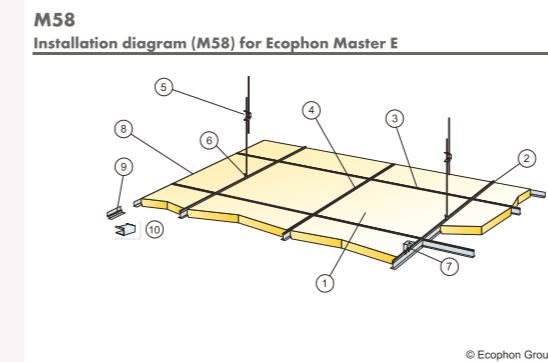

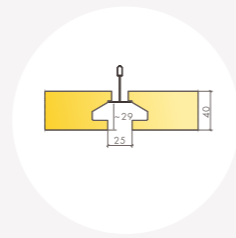

Ecophon Master™ Eg

Acoustic:

Sound Absorption:

Test results according to EN ISO 354. Classification according to EN ISO 11654.

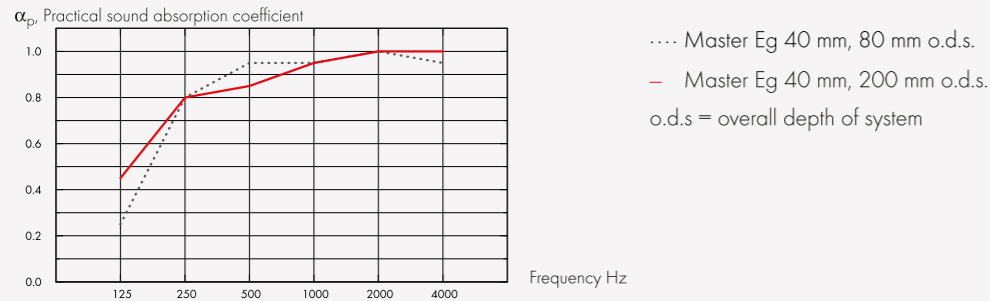

THK mm	o.d.s. mm	α_p , Practical sound absorption coefficient						α_w	Sound absorption class
		125 Hz	250 Hz	500 Hz	1000 Hz	2000 Hz	4000 Hz		
40	80	0.25	0.80	0.95	0.95	1.00	0.95	1.00	A
40	200	0.45	0.80	0.85	0.95	1.00	1.00	0.95	A

THK mm	AC(1.5) Articulation Class, ASTM E1111, ASTM E1110
40	200

Indoor Air Quality:

Certificate / Label

Eurofins Indoor Air Comfort®	IAC
French VOC	A
Finnish M1	•

Environmental Footprint: Life-cycle stages A1 to C4 from EPD, in conformity with ISO 14025 / EN 15804

	kg CO ₂ equiv/m ²
Master Eg	6,10

Circularity: Minimum post-consumer recycled content: 61%, Recyclability: Fully recyclable,

Fire safety: The glass wool core of the tiles is tested and classified as non-combustible according to EN ISO 1182. Europe: EN 13501-1, A2-s1,d0,

Humidity Resistance: Class C, relative humidity 95% and 30°C, according to EN 13964:2014

Visual appearance: White Frost, nearest NCS colour sample S 0500-N, 85% light reflectance. Gloss < 1.

Cleanability: Daily dusting and vacuum cleaning. Weekly wet wiping.

Accessibility: The tiles are easily demountable. Minimum demounting depth according to installation diagrams.

Installation: Installed according to installation diagrams, installation guides and drawing aid. For information regarding minimum overall depth of system see quantity specification.

System weight: The weight of the system (including suspension grid) should be approximately 5 kg/m².

Mechanical properties: See table about Max live load and Min load bearing capacity and Functional demands, Mechanical properties at www.ecophon.com.

CE: Ecophon ceiling systems are CE marked according to the European harmonized standard EN13964:2014. CE marked construction products are covered by a Declaration of Performance (DOP) which enables customers and users to easily compare performance of products available on the European market.

Installation diagram in detail www.ecophon.com

M498
Installation diagram (M498) for Ecophon Master Eg

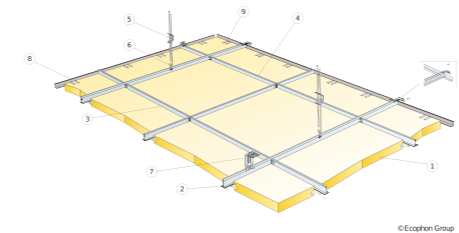

M499
Installation diagram (M499) for Ecophon Master Eg

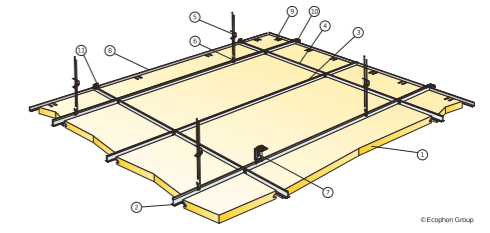

M500
Installation diagram (M500) for Ecophon Master Eg

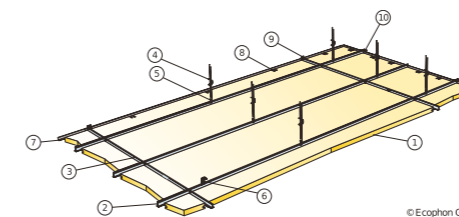

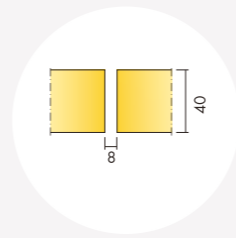

Ecophon Master™ SQ

Acoustic:

Sound Absorption:

Test results according to EN ISO 354. Classification according to EN ISO 11654.

α_p , Practical sound absorption coefficient

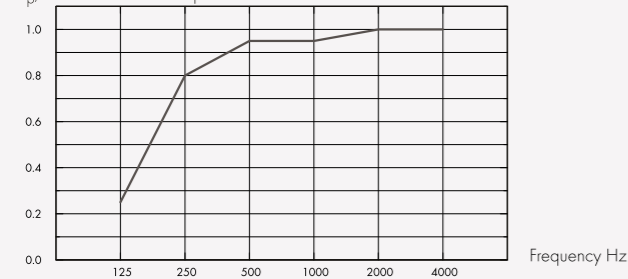

— Master SQ 40 mm, 43 mm o.d.s.
o.d.s = overall depth of system

THK mm	o.d.s. mm	α_p , Practical sound absorption coefficient						α_w	Sound absorption class
		125 Hz	250 Hz	500 Hz	1000 Hz	2000 Hz	4000 Hz		
40	43	0.25	0.80	0.95	0.95	1.00	1.00	1.00	A

Indoor Air Quality:

Certificate / Label

Eurofins Indoor Air Comfort®	IAC
French VOC	A
Finnish M1	•

Environmental Footprint: Life-cycle stages A1 to C4 from EPD, in conformity with ISO 14025 / EN 15804

	kg CO ₂ equiv/m ²
Master SQ	7,20

Circularity: Minimum post-consumer recycled content: 62%, Recyclability: Fully recyclable,

Fire safety: The glass wool core of the tiles is tested and classified as non-combustible according to EN ISO 1182. Europe: EN 13501-1, A2-s1,d0,

Humidity Resistance: Class C, relative humidity 95% and 30°C, according to EN 13964:2014

Visual appearance: White Frost, nearest NCS colour sample S 0500-N, 85% light reflectance. Gloss < 1.

Cleanability: Daily dusting and vacuum cleaning. Weekly wet wiping.

Accessibility: The tiles are not demountable.

Installation: Installed according to installation diagrams, installation guides and drawing aid. For information regarding minimum overall depth of system see quantity specification. Rendered surfaces must have sufficient strength to be able to carry the load imposed by the tiles. If doubts, test gluing should be carried out. The surface should always be dry and clean. For best result the surface should be even, however an acceptable result could be achieved on slightly uneven surfaces.

System weight: The weight of the system should be approximately 5 kg/m².

Mechanical properties: Additional live load has to be fixed to the soffit.

CE: Ecophon ceiling systems are CE marked according to the European harmonized standard EN13964:2014. CE marked construction products are covered by a Declaration of Performance (DOP) which enables customers and users to easily compare performance of products available on the European market.

Installation diagram in detail www.ecophon.com

M106
Installation diagram (M106) for Ecophon Master SQ, using Connect Absorber glue

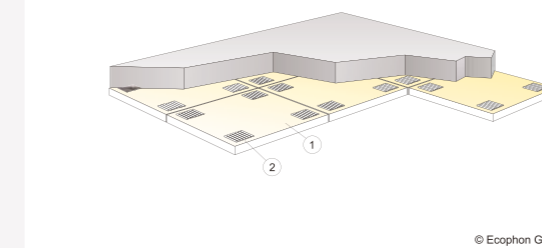

© Ecophon Group

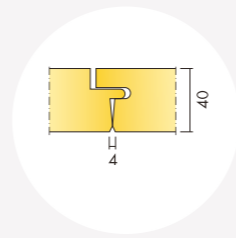

Ecophon Master™ F

Acoustic:

Sound Absorption:

Test results according to EN ISO 354. Classification according to EN ISO 11654, and the single value ratings for Noise Reduction Coefficient, NRC and Sound Absorption Average, SAA according to ASTM C 423.

α_p , Practical sound absorption coefficient

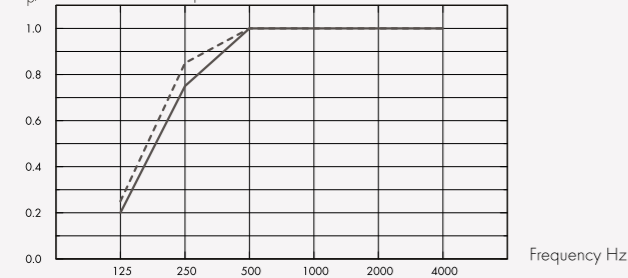

— Master F 40 mm, 40 mm o.d.s.
 --- Master F 40 mm, 60 mm o.d.s.
 o.d.s = overall depth of system

THK mm	o.d.s. mm	α_p , Practical sound absorption coefficient						α_w	Sound absorption class
		125 Hz	250 Hz	500 Hz	1000 Hz	2000 Hz	4000 Hz		
40	40	0.20	0.75	1.00	1.00	1.00	1.00	1.00	A
40	60	0.25	0.85	1.00	1.00	1.00	1.00	1.00	A

	THK mm	o.d.s. mm	NRC	SAA
-	40	40	0.95	0.96
-	40	60	0.95	0.98

Indoor Air Quality:

Certificate / Label

Eurofins Indoor Air Comfort®	IAC
French VOC	A
Finnish M1	•

Environmental Footprint: Life-cycle stages A1 to C4 from EPD, in conformity with ISO 14025 / EN 15804

	kg CO ₂ equiv/m ²
Master F	7,30

Circularity: Minimum post-consumer recycled content: 63%, Recyclability: Fully recyclable,

Fire safety: The glass wool core of the tiles is tested and classified as non-combustible according to EN ISO 1182. Europe: EN 13501-1, A2-s1,d0,

Humidity Resistance: Class C, relative humidity 95% and 30°C, according to EN 13964:2014

Visual appearance: White Frost, nearest NCS colour sample S 0500-N, 85% light reflectance. Gloss < 1.

Cleanability: Daily dusting and vacuum cleaning. Weekly wet wiping.

Accessibility: The tiles are not demountable.

Installation: Installed according to installation diagrams, installation guides and drawing aid. For information regarding minimum overall depth of system see quantity specification. For best result the surface should be even, however an acceptable result could be achieved on slightly uneven surfaces. If very uneven surfaces - installation of furring (evenly spaced timber battens) as the substrate for the tiles is recommended.

System weight: The weight of the system should be approximately 5 kg/m².

Mechanical properties: Additional live load has to be fixed to the soffit.

CE: Ecophon ceiling systems are CE marked according to the European harmonized standard EN13964:2014. CE marked construction products are covered by a Declaration of Performance (DOP) which enables customers and users to easily compare performance of products available on the European market.

Installation diagram in detail www.ecophon.com

M52

Installation diagram (M52) for Ecophon Master F

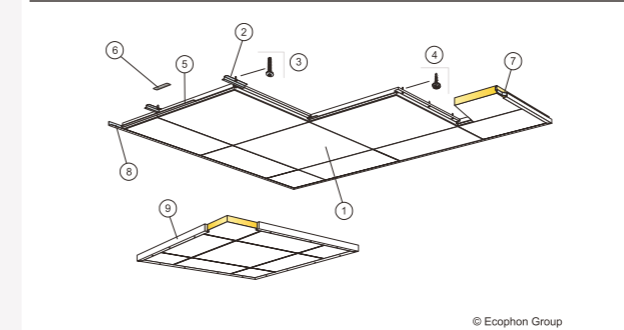

© Ecophon Group

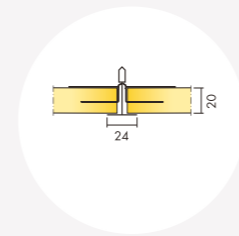

Ecophon Master™ Rigid A

Acoustic:

Sound Absorption:

Test results according to EN ISO 354. Classification according to EN ISO 11654.

α_p , Practical sound absorption coefficient

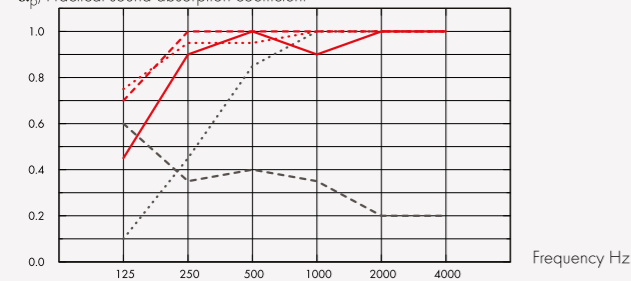

- Master Rigid A 20 mm, 50 mm o.d.s.
 - Master Rigid A 20 mm, 200 mm o.d.s.
 - - - Master Rigid A 20 mm + Extra Bass 50 mm, 200 mm o.d.s.
 - · - · Master Rigid A 20 mm + 2xExtra Bass 100 mm, 200 mm o.d.s.
 - - - Master Rigid A gamma 20 mm, 200 mm o.d.s.
- o.d.s = overall depth of system

	THK mm	o.d.s. mm	α_p , Practical sound absorption coefficient						α_w	Sound absorption class
			125 Hz	250 Hz	500 Hz	1000 Hz	2000 Hz	4000 Hz		
-	20	50	0.10	0.45	0.85	1.00	1.00	1.00	0.75	C
-	20	200	0.45	0.90	1.00	0.90	1.00	1.00	1.00	A
+ Extra Bass	70	200	0.70	1.00	1.00	1.00	1.00	1.00	1.00	A
+ 2xExtra Bass	120	200	0.75	0.95	0.95	1.00	1.00	1.00	1.00	A
gamma	20	200	0.60	0.35	0.40	0.35	0.20	0.20	0.30	D

	THK mm	o.d.s. mm	NRC	SAA
-	20	50	0.80	0.83
-	20	200	0.95	0.93
+ Extra Bass	70	200	1.00	1.00
gamma	20	200	0.35	0.33

Indoor Air Quality:

Certificate / Label

Eurofins Indoor Air Comfort®	IAC
French VOC	A
Finnish M1	•

Environmental Footprint: Life-cycle stages A1 to C4 from EPD, in conformity with ISO 14025 / EN 15804

	kg CO ₂ equiv/m ²
Master Rigid A	2,95

Circularity: Minimum post-consumer recycled content: 46%, Recyclability: Fully recyclable,

Fire safety: The glass wool core of the tiles is tested and classified as non-combustible according to EN ISO 1182. Europe: EN 13501-1, A2-s1,d0,

Humidity Resistance: Class C, relative humidity 95% and 30°C, according to EN 13964:2014

Visual appearance: White Frost, nearest NCS colour sample S 0500-N, 85% light reflectance. Gloss < 1.

Cleanability: Daily dusting and vacuum cleaning. Weekly wet wiping.

Accessibility: The tiles are secured in the grid, but demountable. Minimum demounting depth according to installation diagrams.

Installation: Installed according to installation diagrams, installation guides and drawing aid. For information regarding minimum overall depth of system see quantity specification.

System weight: The weight of the system (including suspension grid and Extra Bass) should be approximately 3,5 kg/m².

Mechanical properties: See table regarding the min- and max- load bearing capacities and functional demands.

Impact Resistance: M316: 3A,

CE: Ecophon ceiling systems are CE marked according to the European harmonized standard EN13964:2014. CE marked construction products are covered by a Declaration of Performance (DOP) which enables customers and users to easily compare performance of products available on the European market.

Installation diagram in detail www.ecophon.com

M316EB

Installation diagram (M316EB) for Ecophon Master Rigid A

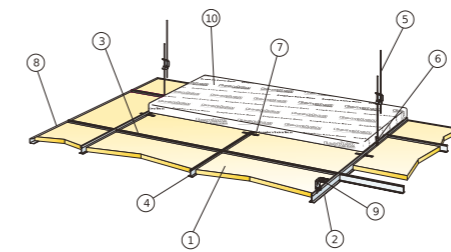

© Ecophon Group

M333

Installation diagram (M333) for Ecophon Master Rigid A XL in corridors

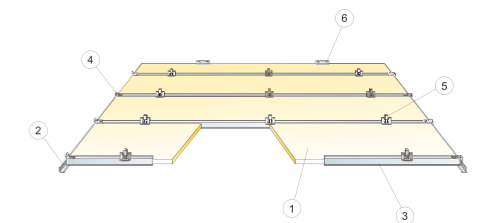

© Ecophon Group

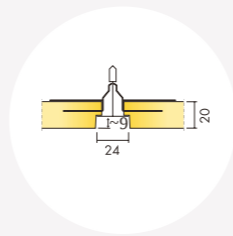

Ecophon Master™ Rigid E

Acoustic:

Sound Absorption:

Test results according to EN ISO 354. Classification according to EN ISO 11654.

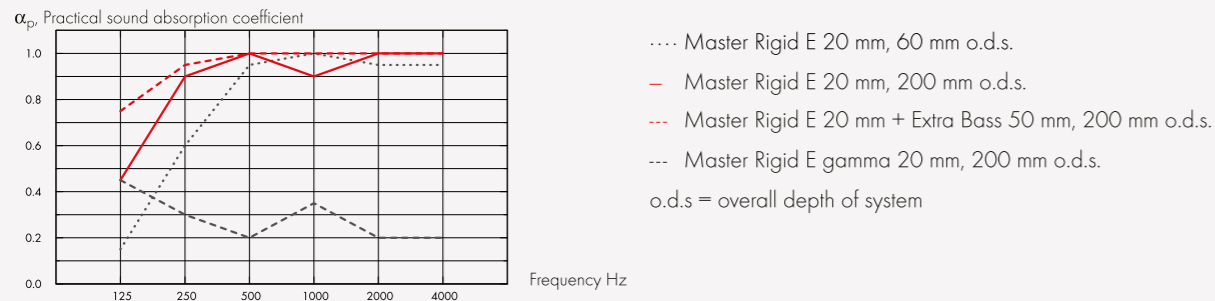

	THK mm	o.d.s. mm	α_p , Practical sound absorption coefficient					α_w	Sound absorption class
			125 Hz	250 Hz	500 Hz	1000 Hz	2000 Hz		
-	20	60	0.15	0.60	0.95	1.00	0.95	0.95	A
-	20	200	0.45	0.90	1.00	0.90	1.00	1.00	A
+ Extra Bass	70	200	0.75	0.95	1.00	1.00	1.00	1.00	A
gamma	20	200	0.45	0.30	0.20	0.35	0.20	0.25	E

Indoor Air Quality:

Certificate / Label

Eurofins Indoor Air Comfort®	IAC
French VOC	A
Finnish M1	•

Environmental Footprint: Life-cycle stages A1 to C4 from EPD, in conformity with ISO 14025 / EN 15804

	kg CO ₂ equiv/m ²
Master Rigid E	3,27

Circularity: Minimum post-consumer recycled content: 45%, Recyclability: Fully recyclable,

Fire safety: The glass wool core of the tiles is tested and classified as non-combustible according to EN ISO 1182. Europe: EN 13501-1, A2-s1,d0,

Humidity Resistance: Class C, relative humidity 95% and 30°C, according to EN 13964:2014

Visual appearance: White Frost, nearest NCS colour sample S 0500-N, 85% light reflectance. Gloss < 1.

Cleanability: Daily dusting and vacuum cleaning. Weekly wet wiping.

Accessibility: The tiles are secured in the grid, but demountable. Minimum demounting depth according to installation diagrams.

Installation: Installed according to installation diagrams, installation guides and drawing aid. For information regarding minimum overall depth of system see quantity specification.

System weight: The weight of the system (including suspension grid) should be approximately 5 kg/m².

Mechanical properties: See table regarding the min- and max- load bearing capacities and functional demands.

Impact Resistance: Tested and classified according to EN 13964 annex D. M317: 3A,

CE: Ecophon ceiling systems are CE marked according to the European harmonized standard EN13964:2014. CE marked construction products are covered by a Declaration of Performance (DOP) which enables customers and users to easily compare performance of products available on the European market.

Installation diagram in detail www.ecophon.com

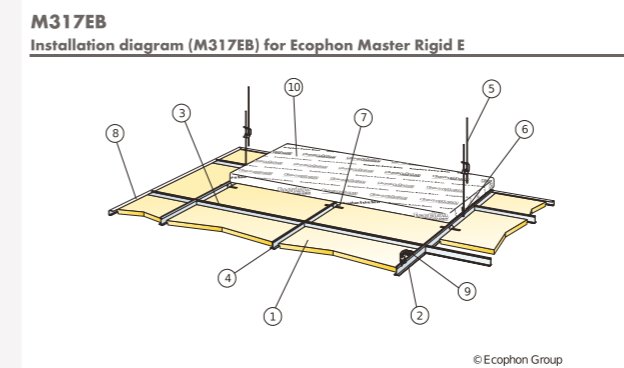

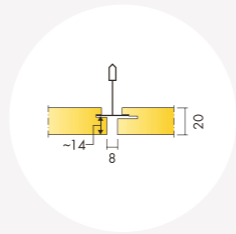

Ecophon Master™ Rigid Dp

Acoustic:

Sound Absorption:

Test results according to EN ISO 354. Classification according to EN ISO 11654.

α_p , Practical sound absorption coefficient

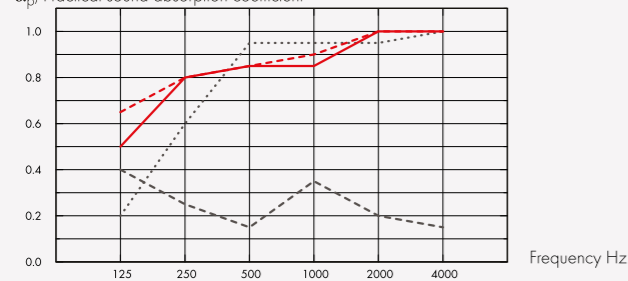

- Master Rigid Dp 20 mm, 65 mm o.d.s.
 - Master Rigid Dp 20 mm, 200 mm o.d.s.
 - - - Master Rigid Dp 20 mm + Extra Bass 50 mm, 200 mm o.d.s.
 - - - Master Rigid Dp gamma 20 mm, 200 mm o.d.s.
- o.d.s = overall depth of system

	THK mm	o.d.s. mm	α_p , Practical sound absorption coefficient					α_w	Sound absorption class	
			125 Hz	250 Hz	500 Hz	1000 Hz	2000 Hz			4000 Hz
-	20	65	0.20	0.60	0.95	0.95	0.95	1.00	0.90	A
-	20	200	0.50	0.80	0.85	0.85	1.00	1.00	0.90	A
+ Extra Bass	70	200	0.65	0.80	0.85	0.90	1.00	1.00	0.90	A
gamma	20	200	0.40	0.25	0.15	0.35	0.20	0.15	0.20	E

Indoor Air Quality:

Certificate / Label

Eurofins Indoor Air Comfort®	IAC
French VOC	A
Finnish M1	•

Environmental Footprint: Life-cycle stages A1 to C4 from EPD, in conformity with ISO 14025 / EN 15804

	kg CO ₂ equiv/m ²
Master Rigid Dp	4,95
Extra Bass	1,62

Circularity: Minimum post-consumer recycled content: 55%, Recyclability: Fully recyclable,

Fire safety: The glass wool core of the tiles is tested and classified as non-combustible according to EN ISO 1182. Europe: EN 13501-1, A2-s1,d0,

Humidity Resistance: Class C, relative humidity 95% and 30°C, according to EN 13964:2014

Visual appearance: White Frost, nearest NCS colour sample S 0500-N, 85% light reflectance. Gloss < 1.

Cleanability: Daily dusting and vacuum cleaning. Weekly wet wiping.

Accessibility: The tiles are secured in the grid, but demountable. Minimum demounting depth according to installation diagrams.

Installation: Installed according to installation diagrams, installation guides and drawing aid. For information regarding minimum overall depth of system see quantity specification.

System weight: The weight of the system (including suspension grid and Extra Bass) should be approximately 4 kg/m².

Mechanical properties: See table regarding the min- and max- load bearing capacities and functional demands.

Impact Resistance: Tested and classified according to EN 13964 annex D. M318: 3A,

CE: Ecophon ceiling systems are CE marked according to the European harmonized standard EN13964:2014. CE marked construction products are covered by a Declaration of Performance (DOP) which enables customers and users to easily compare performance of products available on the European market.

Installation diagram in detail www.ecophon.com

M318EB

Installation diagram (M318EB) for Ecophon Master Rigid Dp

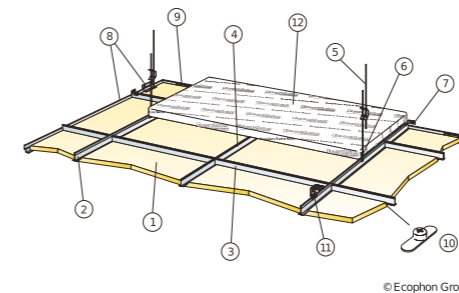

M319

Installation diagram (M319) for Ecophon Master Rigid Dp in corridors

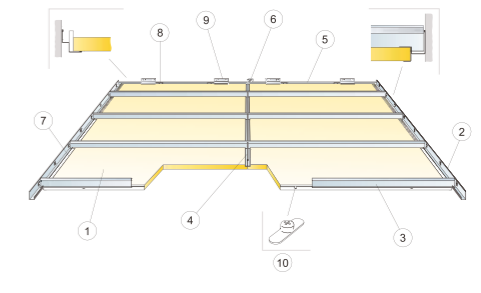



Ecophon is the leading supplier of indoor acoustic solutions that improve working performance and quality of life. We believe in the difference sound can make to our everyday lives, and are passionate advocates for the importance of room acoustics to people's wellbeing - whatever the space, activity or need.

Having a sound effect on people is the principle that guides all we do. We're proud of the Swedish heritage and human approach that promise is founded on. Our uncompromising commitment to transparent sustainable practice. And, as members of the Saint-Gobain Group, to be doing our part in making the world a better home.