

Ecophon Hygiene Clinic™ A

Ecophon Hygiene Clinic™ A has an exposed grid, suitable for dry areas. The absorbers have low emission levels, ensuring high indoor air quality. They are resistant to mould and bacteria growth and withstand HPV cleaning.

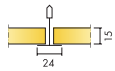

SYSTEM RANGE



| | | |
|-----------------|---------|----------|
| Size, mm | 600x600 | 1200x600 |
| T24 | • | • |
| Thickness (THK) | 15 | 15 |
| Inst. Diag. | M338 | M338 |



Section of Hygiene Clinic A system



Hygiene Clinic A tile



Hygiene Clinic A system

Acoustic



Sound Absorption:

Test results according to EN ISO 354. Classification according to EN ISO 11654.

α_p , Practical sound absorption coefficient

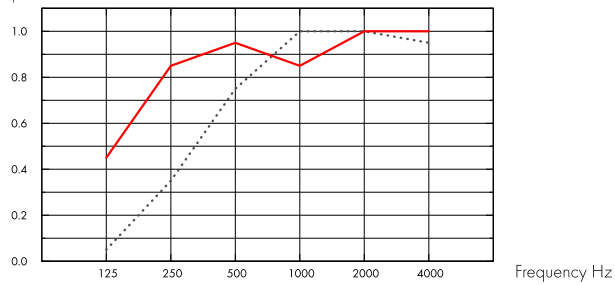

.... Hygiene Clinic A 15 mm, 50 mm o.d.s.
 — Hygiene Clinic A 15 mm, 200 mm o.d.s.
 o.d.s = overall depth of system

| THK mm | o.d.s. mm | α_p , Practical sound absorption coefficient | | | | | | α_w | Sound absorption class |
|-----------|-----------|---|--------|--------|---------|---------|---------|------------|------------------------|
| | | 125 Hz | 250 Hz | 500 Hz | 1000 Hz | 2000 Hz | 4000 Hz | | |
| 15 | 50 | 0.05 | 0.35 | 0.75 | 1.00 | 1.00 | 0.95 | 0.65 | C |
| 15 | 200 | 0.45 | 0.85 | 0.95 | 0.85 | 1.00 | 1.00 | 0.95 | A |

| THK mm | o.d.s. mm | NRC | SAA |
|-----------|-----------|------|------|
| 15 | 50 | 0.80 | 0.79 |
| 15 | 200 | 0.90 | 0.91 |

Indoor Air Quality



| Certificate / Label | |
|------------------------------|----------|
| Eurofins Indoor Air Comfort® | IAC Gold |
| French VOC | A+ |



Cradle to Cradle Certified®



This product is Cradle to Cradle Certified® at Bronze level (version 4.0).



Material Health



This product has received a C2C Certified Material Health Certificate™ at the Silver level (standard version 4.0). The C2C Certified Material Health Certificate™ is a verification of the health and safety of a product's composition using the Material Health requirements of the Cradle-to-Cradle Certified Product Standard.



Carbon footprint

| | kg CO ₂ equiv/m ² |
|------------------|---|
| Hygiene Clinic A | 2,55 |

Life-cycle stages A1 to C4 from EPD, in conformity with ISO 14025 / EN 15804



Circularity

| | |
|--|------------------|
| Minimum post-consumer recycled content | 46% |
| Recyclability | Fully recyclable |



Fire safety

| Country | Fire standard | Class |
|---------|---------------|----------|
| Europe | EN 13501-1 | A2-s1,d0 |

The glass wool core of the tiles is tested and classified as non-combustible according to EN ISO 1182.



Humidity Resistance

Class C, relative humidity 95% and 30°C, according to EN 13964:2014



Visual appearance

White 500, nearest NCS colour sample S 0500-N, 84% light reflectance.



Cleanability

| Standard/Method | Frequency |
|--------------------------|-----------|
| Dusting | Daily |
| Wet wiping | Daily |
| Hydrogen peroxide vapor | • |
| UV-C, BIFMA HCF 8.1-2019 | • |



Mould and Bacterial Resistance

| Standard/Method | Class |
|--|------------------------------------|
| ISO 846 :2019 method A (for fungi) | 0 (No growth under the microscope) |
| ISO 846 :2019 method C (for bacterium) | 0 (No growth under the microscope) |
| ASTM D3273-16 (for fungi) | 10 (0% growth on the surface) |



Clean Room

| | Standard/Method | Class |
|-------------|-------------------------------|-----------|
| ISO 14644 | Particle cleanliness class | ISO 4 |
| NF S 90-351 | Microbiological class | M1/area 4 |
| NF S 90-351 | Particle elimination kinetics | CP(0,5) 5 |



Accessibility

The tiles are easily demountable. Minimum demounting depth according to installation diagrams.



Installation

Installed according to installation diagrams, installation guides and drawing aid. For information regarding minimum overall depth of system see quantity specification.



System weight

| | kg/m ² | Weight information is indicative and subject to variation. |
|--|-------------------|--|
| Hygiene Clinic A | 1,3 | |
| Hygiene Clinic A + Connect grid system | 2,3 | |



Mechanical properties

See table about Max live load and Min load bearing capacity and Functional demands, Mechanical properties at www.ecophon.com.



CE

Ecophon ceiling systems are CE marked according to the European harmonized standard EN 13964:2014. CE marked construction products are covered by a Declaration of Performance (DOP) which enables customers and users to easily compare performance of products available on the European market.

INSTALLATION DIAGRAM (M338) FOR ECOPHON HYGIENE CLINIC™ A

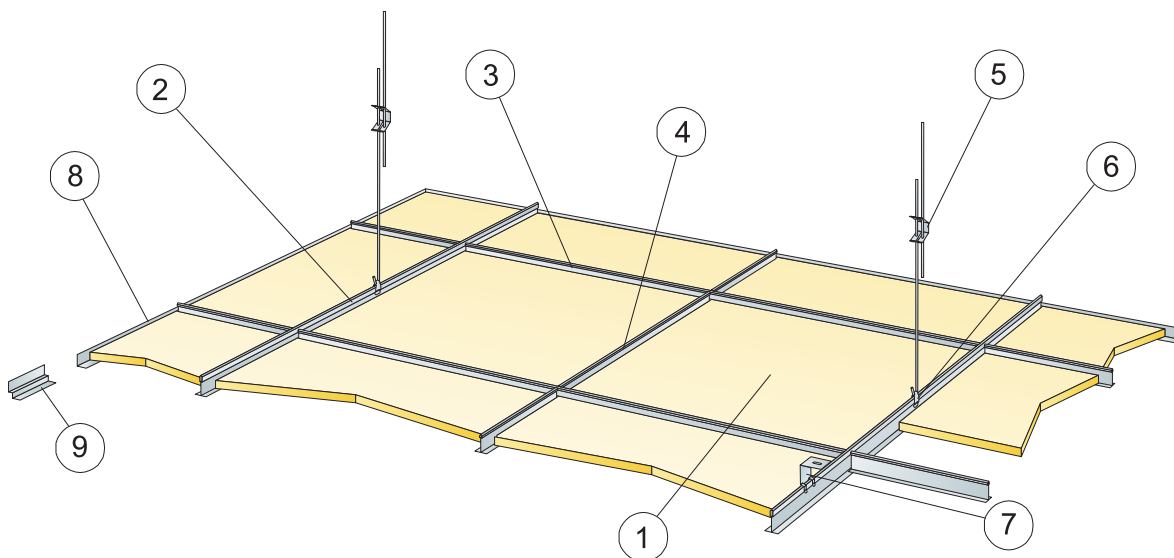

©Saint-Gobain Ecophon AB

QUANTITY SPECIFICATION (EXCL. WASTAGE)

| | Size, mm | |
|--|---------------------|---------------------|
| | 600x600 | 1200x600 |
| 1 Hygiene Clinic A | 2,8/m ² | 1,4/m ² |
| 2 Connect T24 Main Runner, installed at 1200 mm centres | 0,9m/m ² | 0,9m/m ² |
| 3 Connect T24 Cross Tee, L=1200 mm, installed at 600 mm centres | 1,7m/m ² | 1,7m/m ² |
| 4 Connect T24 Cross Tee, L=600 mm | 0,9m/m ² | - |
| 5 Connect Adjustable Hanger, installed at 1200 mm centres (max. distance from wall 600 mm) | 0,7/m ² | 0,7/m ² |
| 6 Connect Hanger Clip (not to be used in swimming hall environments) | 0,7/m ² | 0,7/m ² |
| 7 For direct installation: Connect Direct Bracket, installed at 1200 mm centres | 0,7/m ² | 0,7/m ² |
| 8 Connect Angle Trim, fixed at 300 mm centres | as required | as required |
| 9 Connect Shadow-line Trim, fixed at 300 mm centres | as required | as required |
| Δ Min. overall depth of system, with adjustable hanger: 100 mm, with direct bracket: 50 mm | - | - |
| δ Min. demounting depth: 120 mm | - | - |



See Quantity Specification

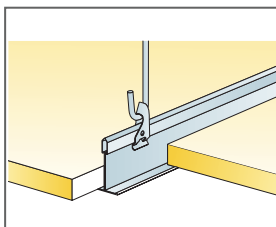

Suspension with Connect Adjustable Hanger and Connect Hanger Clip

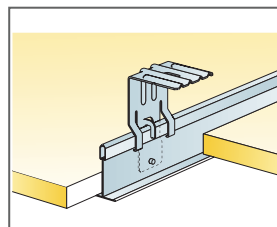

Suspension with Connect Direct Bracket

| Size, mm | Max live load [N] | Min load bearing capacity [N] |
|-------------|-------------------|-------------------------------|
| 600x600x15 | 50 | 160 |
| 1200x600x15 | 50 | 160 |

Live load/load bearing capacity

Ecophon Hygiene Clinic™ E

Ecophon Hygiene Clinic™ E has a recessed visible grid and a tegular edge design, suitable for dry areas. The absorbers have low emission levels, ensuring high indoor air quality. They are resistant to mould and bacteria growth and withstand HPV cleaning.



Centre de dialyse de Pau

SYSTEM RANGE

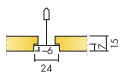

| | | |
|-----------------|---------|----------|
| Size, mm | 600x600 | 1200x600 |
| T24 | • | • |
| Thickness (THK) | 15 | 15 |
| Inst. Diag. | M339 | M339 |



Hygiene Clinic E tile

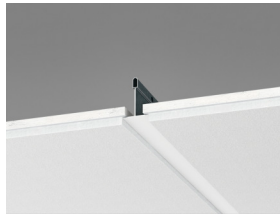

Section of Hygiene Clinic E system



Hygiene Clinic E system

Acoustic



Sound Absorption:

Test results according to EN ISO 354. Classification according to EN ISO 11654, and the single value ratings for Noise Reduction Coefficient, NRC and Sound Absorption Average, SAA according to ASTM C 423.

α_p , Practical sound absorption coefficient

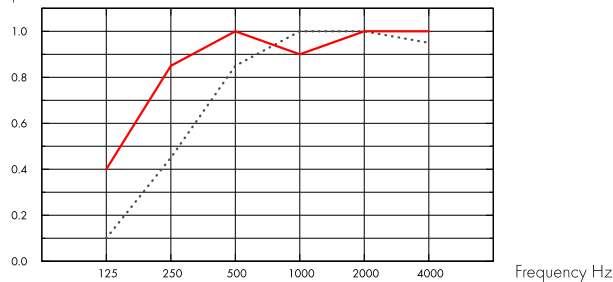

..... Hygiene Clinic E 15 mm, 60 mm o.d.s.
 — Hygiene Clinic E 15 mm, 200 mm o.d.s.
 o.d.s = overall depth of system

| THK mm | o.d.s. mm | α_p , Practical sound absorption coefficient | | | | | | α_w | Sound absorption class |
|-----------|-----------|---|--------|--------|---------|---------|---------|------------|------------------------|
| | | 125 Hz | 250 Hz | 500 Hz | 1000 Hz | 2000 Hz | 4000 Hz | | |
| 15 | 60 | 0.10 | 0.45 | 0.85 | 1.00 | 1.00 | 0.95 | 0.75 | C |
| 15 | 200 | 0.40 | 0.85 | 1.00 | 0.90 | 1.00 | 1.00 | 1.00 | A |



Indoor Air Quality

Certificate / Label

Eurofins Indoor Air Comfort®

IAC Gold



French VOC

A+



Cradle to Cradle Certified®



This product is Cradle to Cradle Certified® at Bronze level (version 4.0).



Material Health



This product has received a C2C Certified Material Health Certificate™ at the Silver level (standard version 4.0). The C2C Certified Material Health Certificate™ is a verification of the health and safety of a product's composition using the Material Health requirements of the Cradle-to-Cradle Certified Product Standard.



Carbon footprint

| | kg CO ₂ equiv/m ² |
|------------------|---|
| Hygiene Clinic E | 2,19 |

Life-cycle stages A1 to C4 from EPD, in conformity with ISO 14025 / EN 15804



Circularity

| | |
|--|------------------|
| Minimum post-consumer recycled content | 45% |
| Recyclability | Fully recyclable |



Fire safety

| Country | Fire standard | Class |
|---------|---------------|----------|
| Europe | EN 13501-1 | A2-s1,d0 |

The glass wool core of the tiles is tested and classified as non-combustible according to EN ISO 1182.



Humidity Resistance

Class C, relative humidity 95% and 30°C, according to EN 13964:2014



Visual appearance

White 500, nearest NCS colour sample S 0500-N, 84% light reflectance.



Cleanability

| Standard/Method | Frequency |
|--------------------------|-----------|
| Dusting | Daily |
| Wet wiping | Daily |
| Hydrogen peroxide vapor | • |
| UV-C, BIFMA HCF 8.1-2019 | • |



Mould and Bacterial Resistance

| Standard/Method | Class |
|--|------------------------------------|
| ISO 846 :2019 method A (for fungi) | 0 (No growth under the microscope) |
| ISO 846 :2019 method C (for bacterium) | 0 (No growth under the microscope) |
| ASTM D3273-16 (for fungi) | 10 (0% growth on the surface) |



Clean Room

| | Standard/Method | Class |
|-------------|-------------------------------|-----------|
| ISO 14644 | Particle cleanliness class | ISO 4 |
| NF S 90-351 | Microbiological class | M1/area 4 |
| NF S 90-351 | Particle elimination kinetics | CP(0,5) 5 |



Accessibility

The tiles are easily demountable. Minimum demounting depth according to installation diagrams.



Installation

Installed according to installation diagrams, installation guides and drawing aid. For information regarding minimum overall depth of system see quantity specification.



System weight

| | kg/m ² | Weight information is indicative and subject to variation. |
|--|-------------------|--|
| Hygiene Clinic E | 1,3 | |
| Hygiene Clinic E + Connect grid system | 2,3 | |



Mechanical properties

See table about Max live load and Min load bearing capacity and Functional demands, Mechanical properties at www.ecophon.com.



CE

Ecophon ceiling systems are CE marked according to the European harmonized standard EN13964:2014. CE marked construction products are covered by a Declaration of Performance (DOP) which enables customers and users to easily compare performance of products available on the European market.



© Saint-Gobain Ecophon AB

QUANTITY SPECIFICATION (EXCL. WASTAGE)

| | Size, mm | |
|--|---------------------|---------------------|
| | 600x600 | 1200x600 |
| 1 Hygiene Clinic E | 2,8/m ² | 1,4/m ² |
| 2 Connect T24 Main Runner, installed at 1200 mm centres | 0,9m/m ² | 0,9m/m ² |
| 3 Connect T24 Cross Tee, L=1200 mm, installed at 600 mm centres | 1,7m/m ² | 1,7m/m ² |
| 4 Connect T24 Cross Tee, L=600 mm | 0,9m/m ² | - |
| 5 Connect Adjustable Hanger, installed at 1200 mm centres (max. distance from wall 600 mm) | 0,7/m ² | 0,7/m ² |
| 6 Connect Hanger Clip (not to be used in swimming hall environments) | 0,7/m ² | 0,7/m ² |
| 7 For direct installation: Connect Direct Bracket, installed at 1200 mm centres | 0,7/m ² | 0,7/m ² |
| 8 Connect Angle Trim, fixed at 300 mm centres | as required | as required |
| 9 Connect Shadow-line Trim, fixed at 300 mm centres | as required | as required |
| 10 Connect E-plug (for Connect Shadow-line Trim) | as required | as required |
| Δ Min. overall depth of system, with adjustable hanger: 110 mm, with direct bracket: 60 mm | - | - |
| δ Min. demounting depth: T15: 110 mm, T24: 90 mm | - | - |

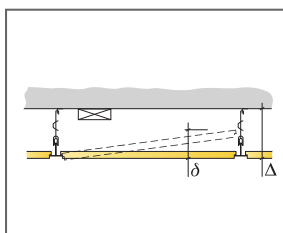

See Quantity Specification

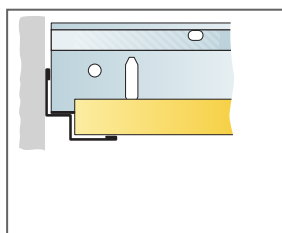

Straight cut and T-profile on top of Connect Shadow-line Trim

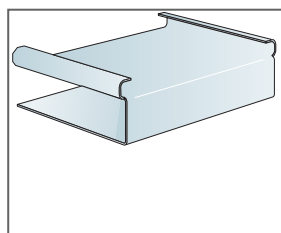

Connect E-plug

| Size, mm | Max live load [N] | Min load bearing capacity [N] |
|-------------|-------------------|-------------------------------|
| 600x600x15 | 50 | 160 |
| 1200x600x15 | 50 | 160 |

Live load/load bearing capacity



Ecophon Hygiene Meditec™

A

Ecophon Hygiene Meditec™ A has an exposed grid, suitable for dry areas where disinfection and/or cleaning is required on a regular basis. The surface is resistant to mould and bacteria growth and common detergents and disinfectants. The absorbers have low emission levels, ensuring high indoor air quality.



Spain

SYSTEM RANGE

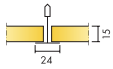

| | | |
|-----------------|---------|----------|
| Size, mm | 600x600 | 1200x600 |
| T24 | • | • |
| Thickness (THK) | 15 | 15 |
| Inst. Diag. | M255 | M255 |

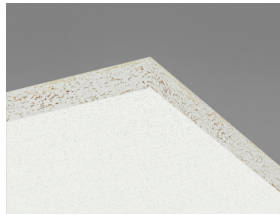

Hygiene Meditec A tile



Hygiene Meditec A C1 section with Connect Universal clip



Hygiene Meditec A C1 system

Acoustic



Sound Absorption:

Test results according to EN ISO 354. Classification according to EN ISO 11654.

α_p , Practical sound absorption coefficient

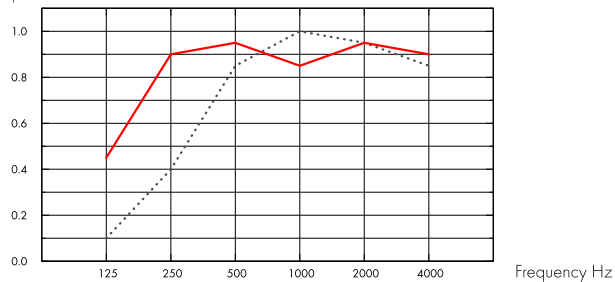

···· Hygiene Meditec A 15 mm, 50 mm o.d.s.
 — Hygiene Meditec A 15 mm, 200 mm o.d.s.
 o.d.s = overall depth of system

| THK mm | o.d.s. mm | α_p , Practical sound absorption coefficient | | | | | | α_w | Sound absorption class |
|-----------|-----------|---|--------|--------|---------|---------|---------|------------|------------------------|
| | | 125 Hz | 250 Hz | 500 Hz | 1000 Hz | 2000 Hz | 4000 Hz | | |
| 15 | 50 | 0.10 | 0.40 | 0.85 | 1.00 | 0.95 | 0.85 | 0.70 | C |
| 15 | 200 | 0.45 | 0.90 | 0.95 | 0.85 | 0.95 | 0.90 | 0.95 | A |

| THK mm | o.d.s. mm | NRC | SAA |
|-----------|-----------|------|------|
| 15 | 50 | 0.80 | 0.83 |
| 15 | 400 | 0.85 | 0.89 |

Indoor Air Quality



| Certificate / Label | |
|------------------------------|----------|
| Eurofins Indoor Air Comfort® | IAC Gold |
| French VOC | A+ |



Cradle to Cradle Certified®



This product is Cradle to Cradle Certified® at Bronze level (version 4.0).



Material Health



This product has received a C2C Certified Material Health Certificate™ at the Silver level (standard version 4.0). The C2C Certified Material Health Certificate™ is a verification of the health and safety of a product's composition using the Material Health requirements of the Cradle-to-Cradle Certified Product Standard.



Carbon footprint

| | kg CO ₂ equiv/m ² |
|-------------------|---|
| Hygiene Meditec A | 2,71 |

Life-cycle stages A1 to C4 from EPD, in conformity with ISO 14025 / EN 15804



Circularity

| | |
|--|------------------|
| Minimum post-consumer recycled content | 44% |
| Recyclability | Fully recyclable |



Fire safety

| Country | Fire standard | Class |
|---------|---------------|----------|
| Europe | EN 13501-1 | A2-s1,d0 |

The glass wool core of the tiles is tested and classified as non-combustible according to EN ISO 1182.



Humidity Resistance

Class C, relative humidity 95% and 30°C, according to EN 13964:2014



Visual appearance

White 500, nearest NCS colour sample S 0500-N, 84% light reflectance.



Cleanability

| Standard/Method | Frequency |
|-------------------------|-----------|
| Dusting | Daily |
| Wet wiping | Daily |
| Steam cleaning | 1/year |
| Hydrogen peroxide vapor | • |



Surface Endurance

Product tested according to ISO 11998, and withstand 200 cycles.



Chemical resistance/Disinfection

| Chemical | Active Substance | Concentration |
|-------------|---|---------------|
| Ethanol | Ethanol | 70% |
| Chlorine | Sodium Hypochlorite solution | 2,5% |
| Virkon S | Dipotassium peroxodisulphate; Sulphamic acid | 1% |
| Isopropanol | Isopropyl Alcohol | 70% |

Tested according to ISO 11998 and withstand the following chemicals or disinfectants.



Mould and Bacterial Resistance

| Standard/Method | Class |
|--|------------------------------------|
| ISO 846 :2019 method C (for bacterium) | 0 (No growth under the microscope) |
| ASTM D3273-16 (for fungi) | 10 (0% growth on the surface) |



Clean Room

| Standard/Method | Class |
|-----------------|---|
| ISO 14644 | Particle cleanliness class ISO 4 |
| NF S 90-351 | Microbiological class M1/area 4 |
| NF S 90-351 | Particle elimination kinetics CP(0,5) 5 |



Accessibility

The tiles are demountable. Minimum demounting depth according to installation diagram. The tiles are secured using clips to allow for effective cleaning. The clips are easily removable from above the ceiling. An easy-to-open Connect Inspection hatch is available to simplify access to the ceiling void.



Installation

Installed according to installation diagrams, installation guides and drawing aid. Cut panels must be sealed with Connect Edge sealant. Penetrations must be sealed with a suitable sealant.



Mechanical properties

See table about Max live load and Min load bearing capacity and Functional demands, Mechanical properties at www.ecophon.com.



System weight

| | kg/m ² | Weight information is indicative and subject to variation. |
|---|-------------------|--|
| Hygiene Meditec A | 1,3 | |
| Hygiene Meditec A + Connect grid system | 2,3 | |



CE

Ecophon ceiling systems are CE marked according to the European harmonized standard EN13964:2014. CE marked construction products are covered by a Declaration of Performance (DOP) which enables customers and users to easily compare performance of products available on the European market.

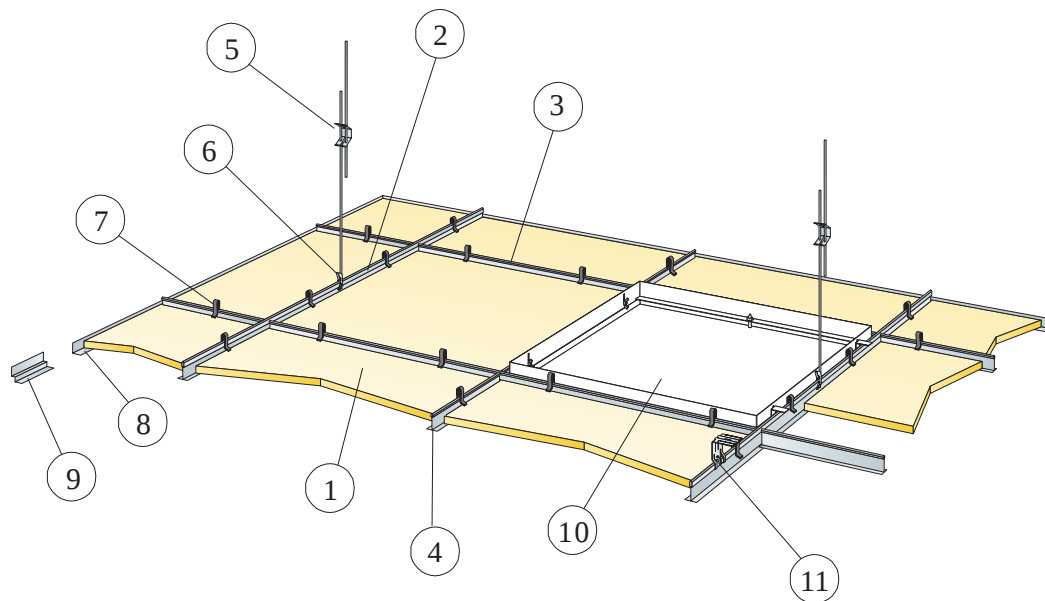

© Saint-Gobain Ecophon AB

QUANTITY SPECIFICATION (EXCL. WASTAGE)

| | Size, mm | |
|--|---------------------|---------------------|
| | 600x600 | 1200x600 |
| 1 Hygiene Meditec A | 2,8/m ² | 1,4/m ² |
| 2 Connect T24 Main Runner, installed at 1200 mm centres | 0,9m/m ² | 0,9m/m ² |
| 3 Connect T24 Cross Tee, L=1200 mm, installed at 600 mm centres | 1,7m/m ² | 1,7m/m ² |
| 4 Connect T24 Cross Tee, L=600 mm | 0,9m/m ² | - |
| 5 Connect Adjustable Hanger, installed at 1200 mm centres (max. distance from wall 600 mm) | 0,7/m ² | 0,7/m ² |
| 6 Connect Hanger Clip (not to be used in swimming hall environments) | 0,7/m ² | 0,7/m ² |
| 7 Connect Universal Clip | 11/m ² | 7/m ² |
| 8 Alt. Connect Angle Trim, fixed c300 | as required | as required |
| 9 Alt. Connect Shadow-line Trim, fixed c300 | as required | as required |
| 10 Connect Inspection Hatch | as required | as required |
| 11 For direct installation: Connect Direct Bracket, installed at 1200 mm centres | 0,7/m ² | 0,7/m ² |
| Δ Min. overall depth of system, with adjustable hanger and clip: 150 mm, with direct fixing without clip: 50 mm. | - | - |
| δ Min. demounting depth: With clip: 150 mm. Without clip: 100 mm. | - | - |

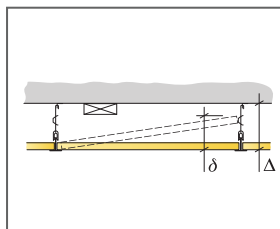

See Quantity Specification

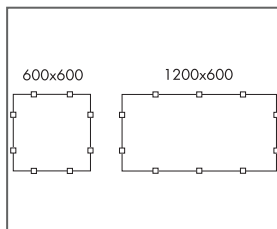

Arrangement of clips

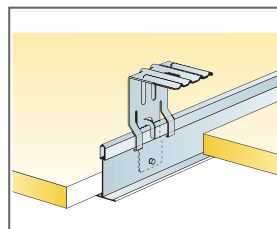

Suspension with Connect Direct Bracket

| Size, mm | Max live load [N] | Min load bearing capacity [N] |
|-------------|-------------------|-------------------------------|
| 600x600x15 | 50 | 160 |
| 1200x600x15 | 50 | 160 |

Live load/load bearing capacity

Ecophon Hygiene Meditec™ E

Ecophon Hygiene Meditec™ E has a recessed visible grid and a tegular edge design, suitable for dry areas where disinfection and/or cleaning is required on a regular basis. The surface is resistant to mould and bacteria growth and to common detergents and disinfectants.



Notaufnahme UKSH, Lübeck, Germany

SYSTEM RANGE

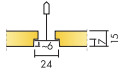

| | | |
|-----------------|---------|----------|
| Size, mm | 600x600 | 1200x600 |
| T24 | • | • |
| Thickness (THK) | 15 | 15 |
| Inst. Diagr. | M256 | M256 |

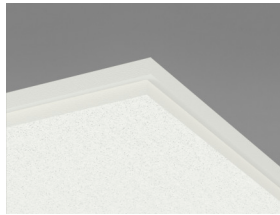

Hygiene Meditec E tile



Hygiene Meditec E C1 section with Connect Universal clip

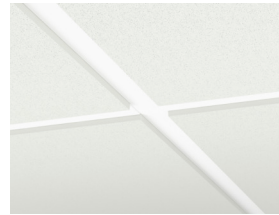

Hygiene Meditec E C1 system

Acoustic



Sound Absorption:

Test results according to EN ISO 354. Classification according to EN ISO 11654.

α_p , Practical sound absorption coefficient

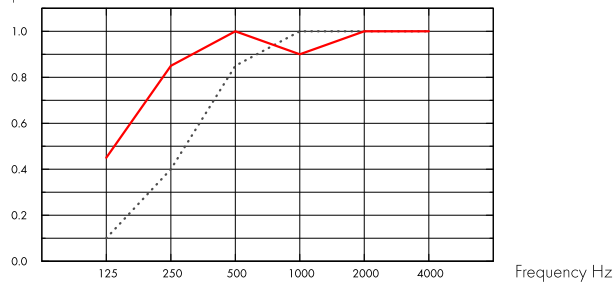

... Hygiene Meditec E 15 mm, 60 mm o.d.s.

— Hygiene Meditec E 15 mm, 200 mm o.d.s.

o.d.s = overall depth of system

| THK mm | o.d.s. mm | α_p , Practical sound absorption coefficient | | | | | | α_w | Sound absorption class |
|-----------|-----------|---|--------|--------|---------|---------|---------|------------|------------------------|
| | | 125 Hz | 250 Hz | 500 Hz | 1000 Hz | 2000 Hz | 4000 Hz | | |
| 15 | 60 | 0.10 | 0.40 | 0.85 | 1.00 | 1.00 | 1.00 | 0.70 | C |
| 15 | 200 | 0.45 | 0.85 | 1.00 | 0.90 | 1.00 | 1.00 | 1.00 | A |

| THK mm | o.d.s. mm | NRC | SAA |
|-----------|-----------|------|------|
| 15 | 60 | 0.90 | 0.87 |
| 15 | 400 | 0.85 | 0.89 |

Indoor Air Quality



| Certificate / Label | |
|------------------------------|----------|
| Eurofins Indoor Air Comfort® | IAC Gold |
| French VOC | A+ |



Cradle to Cradle Certified®



This product is Cradle to Cradle Certified® at Bronze level (version 4.0).



Material Health



This product has received a C2C Certified Material Health Certificate™ at the Silver level (standard version 4.0). The C2C Certified Material Health Certificate™ is a verification of the health and safety of a product's composition using the Material Health requirements of the Cradle-to-Cradle Certified Product Standard.



Carbon footprint

| | kg CO ₂ equiv/m ² |
|-------------------|---|
| Hygiene Meditec E | 2,37 |

Life-cycle stages A1 to C4 from EPD, in conformity with ISO 14025 / EN 15804



Circularity

| | |
|--|------------------|
| Minimum post-consumer recycled content | 43% |
| Recyclability | Fully recyclable |



Fire safety

| Country | Fire standard | Class |
|---------|---------------|----------|
| Europe | EN 13501-1 | A2-s1,d0 |

The glass wool core of the tiles is tested and classified as non-combustible according to EN ISO 1182.



Humidity Resistance

Class C, relative humidity 95% and 30°C, according to EN 13964:2014



Visual appearance

White 500, nearest NCS colour sample S 0500-N, 84% light reflectance.



Cleanability

| Standard/Method | Frequency |
|-------------------------|-----------|
| Dusting | Daily |
| Wet wiping | Daily |
| Steam cleaning | 1/year |
| Hydrogen peroxide vapor | • |



Surface Endurance

Product tested according to ISO 11998, and withstand 200 cycles.



Chemical resistance/Disinfection

| Chemical | Active Substance | Concentration |
|-------------|---|---------------|
| Ethanol | Ethanol | 70% |
| Chlorine | Sodium Hypochlorite solution | 2,5% |
| Virkon S | Dipotassium peroxodisulphate; Sulphamic acid | 1% |
| Isopropanol | Isopropyl Alcohol | 70% |

Tested according to ISO 11998 and withstand the following chemicals or disinfectants.



Mould and Bacterial Resistance

| Standard/Method | Class |
|--|------------------------------------|
| ISO 846 :2019 method C (for bacterium) | 0 (No growth under the microscope) |
| ASTM D3273-16 (for fungi) | 10 (0% growth on the surface) |



Clean Room

| Standard/Method | Class |
|-----------------|---|
| ISO 14644 | Particle cleanliness class ISO 4 |
| NF S 90-351 | Microbiological class M1/area 4 |
| NF S 90-351 | Particle elimination kinetics CP(0,5) 5 |



Accessibility

The tiles are demountable. Minimum demounting depth according to installation diagram. The tiles are secured using clips to allow for effective cleaning. The clips are easily removable from above the ceiling. An easy-to-open Connect Inspection hatch is available to simplify access to the ceiling void.



Installation

Installed according to installation diagrams, installation guides and drawing aid. Cut panels must be sealed with Connect Edge sealant.



System weight

| | kg/m ² | Weight information is indicative and subject to variation. |
|---|-------------------|--|
| Hygiene Meditec E | 1,4 | |
| Hygiene Meditec E + Connect grid system | 2,4 | |



Mechanical properties

See table about Max live load and Min load bearing capacity and Functional demands, Mechanical properties at www.ecophon.com.



CE

Ecophon ceiling systems are CE marked according to the European harmonized standard EN13964:2014. CE marked construction products are covered by a Declaration of Performance (DOP) which enables customers and users to easily compare performance of products available on the European market.

INSTALLATION DIAGRAM (M256) FOR ECOPHON HYGIENE MEDITEC™ E

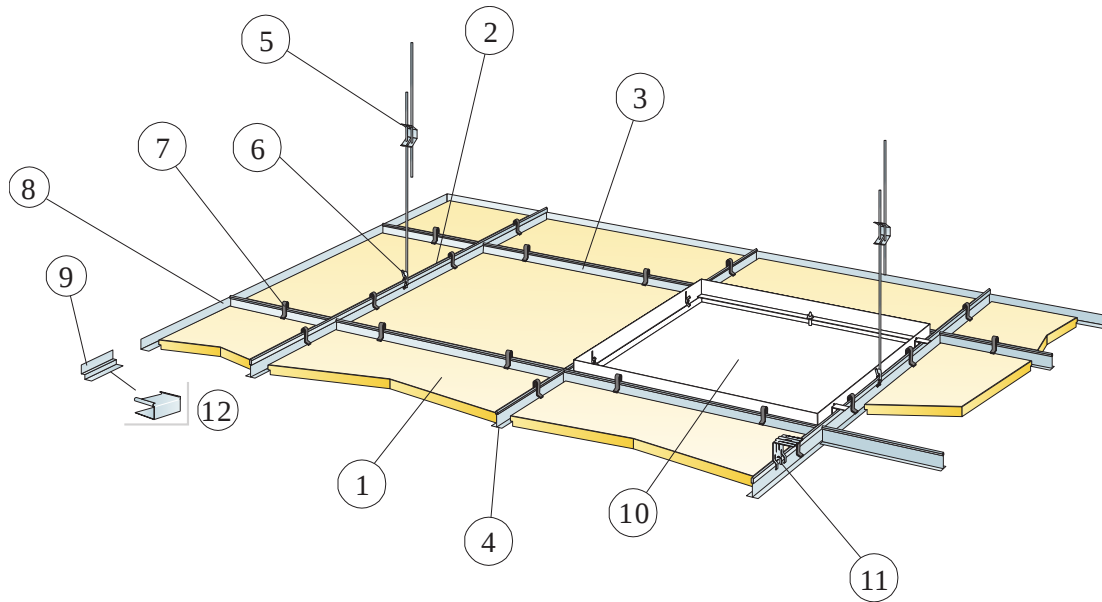

© Saint-Gobain Ecophon AB

QUANTITY SPECIFICATION (EXCL. WASTAGE)

| | Size, mm | |
|--|---------------------|---------------------|
| | 600x600 | 1200x600 |
| 1 Hygiene Meditec E | 2,8/m ² | 1,4/m ² |
| 2 Connect T24 Main Runner, installed at 1200 mm centres | 0,9m/m ² | 0,9m/m ² |
| 3 Connect T24 Cross Tee, L=1200 mm, installed at 600 mm centres | 1,7m/m ² | 1,7m/m ² |
| 4 Connect T24 Cross Tee, L=600 mm | 0,9m/m ² | - |
| 5 Connect Adjustable Hanger, installed at 1200 mm centres (max. distance from wall 600 mm) | 0,7/m ² | 0,7/m ² |
| 6 Connect Hanger Clip (not to be used in swimming hall environments) | 0,7/m ² | 0,7/m ² |
| 7 Connect Universal Clip | 11/m ² | 7/m ² |
| 8 Alt. Connect Angle Trim, fixed c300 | as required | as required |
| 9 Alt. Connect Shadow-line Trim, fixed c300 | as required | as required |
| 10 Connect Inspection Hatch | as required | as required |
| 11 For direct installation: Connect Direct Bracket, installed at 1200 mm centres | 0,7/m ² | 0,7/m ² |
| 12 Connect E-plug (for Connect Shadow-line Trim) | as required | as required |
| Δ Min. overall depth of system, with adjustable hanger and clip: 160 mm, with direct fixing without clip: 60 mm. | - | - |
| δ Min. demounting depth: With clip: 160 mm. Without clip: 110 mm. | - | - |

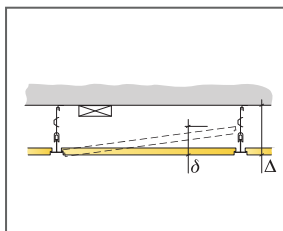

See Quantity Specification

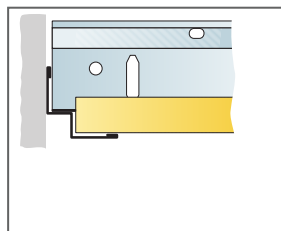

Straight cut and T-profile on top of Connect Shadow-line Trim

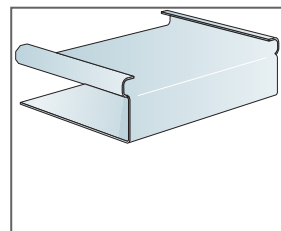

Connect E-plug

| Size, mm | Max live load [N] | Min load bearing capacity [N] |
|-------------|-------------------|-------------------------------|
| 600x600x15 | 50 | 160 |
| 1200x600x15 | 50 | 160 |

Live load/load bearing capacity

Ecophon Hygiene Protec™ A

Ecophon Hygiene Protec™ A has an exposed grid and are particle-repellent for clean rooms, where disinfection and/or cleaning is required on a regular basis. The fully sealed absorbers have low emission levels, ensuring high indoor air quality. They are resistant to mould and bacteria growth.



Unilever Polska, Poland

SYSTEM RANGE

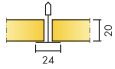

| | | | |
|-----------------|---------|----------|----------|
| Size, mm | 600x600 | 625x625 | 1200x600 |
| T24 | • | • | • |
| Thickness (THK) | 20 | 20 | 20 |
| Inst. Diag. | M257 | M257 DIN | M257 |

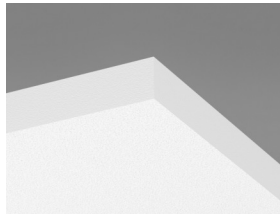

Hygiene Protec A tile

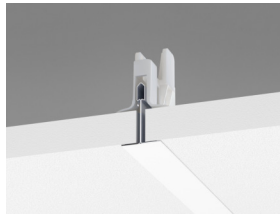

Hygiene Protec A C1 section with Connect Hygiene clip 20



Hygiene Protec A system

Acoustic



Sound Absorption:

Test results according to EN ISO 354. Classification according to EN ISO 11654, and the single value ratings for Noise Reduction Coefficient, NRC and Sound Absorption Average, SAA according to ASTM C 423.

α_p , Practical sound absorption coefficient

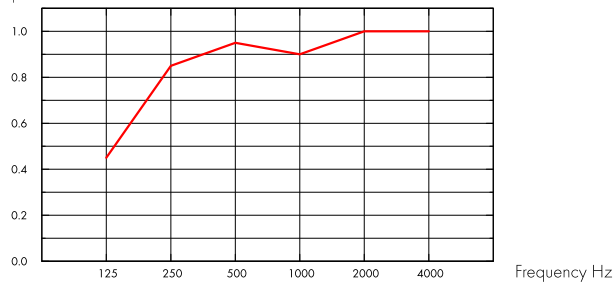

— Hygiene Protec A 20 mm, 200 mm o.d.s.
o.d.s = overall depth of system

| THK mm | o.d.s. mm | α_p , Practical sound absorption coefficient | | | | | | α_w | Sound absorption class |
|-----------|-----------|---|--------|--------|---------|---------|---------|------------|------------------------|
| | | 125 Hz | 250 Hz | 500 Hz | 1000 Hz | 2000 Hz | 4000 Hz | | |
| 20 | 200 | 0.45 | 0.85 | 0.95 | 0.90 | 1.00 | 1.00 | 0.95 | A |

| THK mm | o.d.s. mm | NRC | SAA |
|-----------|-----------|------|------|
| 20 | 200 | 0.95 | 0.98 |

Indoor Air Quality



| Certificate / Label | |
|------------------------------|----------|
| Eurofins Indoor Air Comfort® | IAC Gold |
| French VOC | A+ |



Cradle to Cradle Certified®



This product is Cradle to Cradle Certified® at Bronze level (version 4.0).



Material Health



This product has received a C2C Certified Material Health Certificate™ at the Silver level (standard version 4.0). The C2C Certified Material Health Certificate™ is a verification of the health and safety of a product's composition using the Material Health requirements of the Cradle-to-Cradle Certified Product Standard.



Carbon footprint

| | kg CO ₂ equiv/m ² | Life-cycle stages A1 to C4 from EPD, in conformity with ISO 14025 / EN 15804 |
|------------------|---|--|
| Hygiene Protec A | 5,25 | |



Circularity

| | |
|--|------------------|
| Minimum post-consumer recycled content | 44% |
| Recyclability | Fully recyclable |



Fire safety

| Country | Fire standard | Class | The glass wool core of the tiles is tested and classified as non-combustible according to EN ISO 1182. |
|---------|---------------|----------|--|
| Europe | EN 13501-1 | A2-s1,d0 | |



Humidity Resistance

Class C, relative humidity 95% and 30°C, according to EN 13964:2014



Visual appearance

White 500, nearest NCS colour sample S 0500-N, 84% light reflectance.



Cleanability

| Standard/Method | Frequency |
|-------------------------|-----------|
| Dusting | Daily |
| Wet wiping | Weekly |
| Steam cleaning | 4/year |
| Hydrogen peroxide vapor | • |



Surface Endurance

Product tested according to ISO 11998, and withstand 200 cycles.



Chemical resistance/Disinfection

| Chemical | Active Substance | Concentration | Tested according to ISO 11998 and withstand the following chemicals or disinfectants. |
|-------------|---|---------------|---|
| Ethanol | Ethanol | 70% | |
| Chlorine | Sodium Hypochlorite solution | 2,5% | |
| Virkon S | Dipotassium peroxodisulphate; Sulphamic acid | 1% | |
| Isopropanol | Isopropyl Alcohol | 70% | |



Mould and Bacterial Resistance

| Standard/Method | Class |
|--|------------------------------------|
| ISO 846 :2019 method C (for bacterium) | 0 (No growth under the microscope) |
| ASTM D3273-16 (for fungi) | 10 (0% growth on the surface) |



Clean Room

| Standard/Method | Class |
|-----------------|---|
| ISO 14644 | Particle cleanliness class ISO 3 |
| NF S 90-351 | Microbiological class M1/area 4 |
| NF S 90-351 | Particle elimination kinetics CP(0,5) 1 |



System weight

| | kg/m ² |
|--|-------------------|
| Hygiene Protec A | 1,5 |
| Hygiene Protec A + Connect grid system | 2,5 |

Weight information is indicative and subject to variation.



Installation

Installed according to installation diagrams, installation guides and drawing aid. Cut panels must be sealed with Connect Edge sealant. Penetrations must be sealed with a suitable sealant.



Accessibility

The tiles are demountable. Minimum demounting depth according to installation diagram. The tiles are secured using clips to allow for effective cleaning. The clips are easily removable from above the ceiling. An easy-to-open Connect Inspection hatch is available to simplify access to the ceiling void.



Mechanical properties

See table about Max live load and Min load bearing capacity and Functional demands, Mechanical properties at www.ecophon.com.



CE

Ecophon ceiling systems are CE marked according to the European harmonized standard EN13964:2014. CE marked construction products are covered by a Declaration of Performance (DOP) which enables customers and users to easily compare performance of products available on the European market.

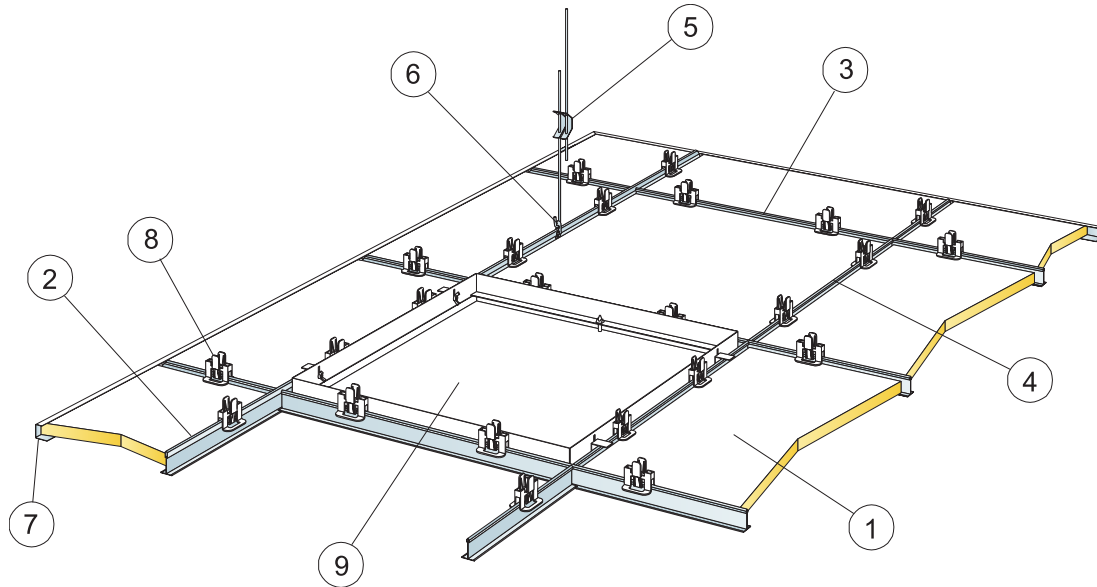

© Saint-Gobain Ecophon AB

QUANTITY SPECIFICATION (EXCL. WASTAGE)

| | Size, mm | |
|--|---------------------|---------------------|
| | 600x600 | 1200x600 |
| 1 Hygiene Protec A | 2,8/m ² | 1,4/m ² |
| 2 Connect T24 Main Runner, installed at 1200 mm centres | 0,9m/m ² | 0,9m/m ² |
| 3 Connect T24 Cross Tee, L=1200 mm, installed at 600 mm centres | 1,7m/m ² | 1,7m/m ² |
| 4 Connect T24 Cross Tee, L=600 mm | 0,9m/m ² | - |
| 5 Connect Adjustable Hanger, installed at 1200 mm centres (max. distance from wall 600 mm) | 0,7/m ² | 0,7/m ² |
| 6 Connect Hanger Clip (not to be used in swimming hall environments) | 0,7/m ² | 0,7/m ² |
| 7 Connect Channel Trim, fixed c300 | as required | as required |
| 8 Connect Hygiene Clip 20 | 11/m ² | 7/m ² |
| 9 Connect Inspection Hatch | as required | as required |
| Δ Min. overall depth of system: 150 mm | - | - |
| δ Min. demounting depth: 150 mm | - | - |

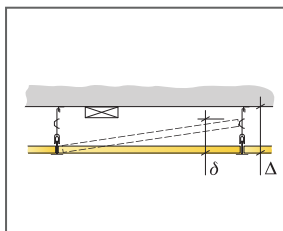

See Quantity Specification

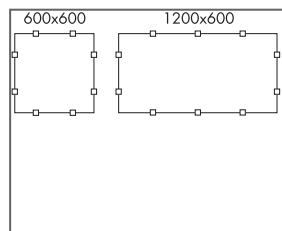

Arrangement of clips

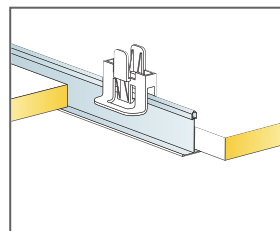

Connect Hygiene Clips for keeping tiles in position

| Size, mm | Max live load [N] | Min load bearing capacity [N] |
|-------------|-------------------|-------------------------------|
| 600x600x20 | 50 | 160 |
| 1200x600x20 | 50 | 160 |

Live load/load bearing capacity

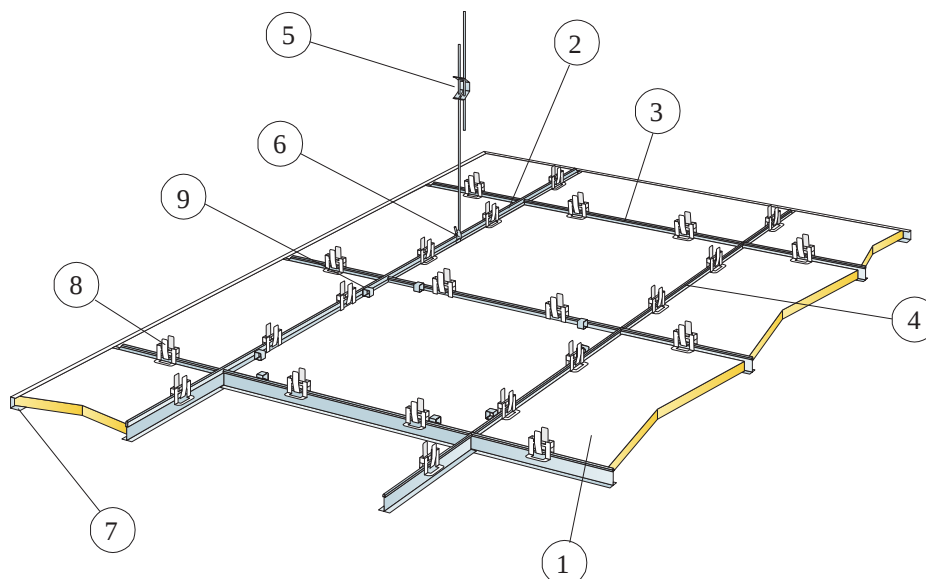

© Saint-Gobain Ecophon AB

QUANTITY SPECIFICATION (EXCL. WASTAGE)

| | Size, mm |
|--|---------------------|
| | 625x625 |
| 1 | 2,6/m ² |
| 2 Connect T24 Main Runner, installed at 1250 mm centres for DIN (only white profiles) | 0,8m/m ² |
| 3 Connect T24 or T15 Cross Tee, L=1250 mm, installed at 625 mm centres | 1,6m/m ² |
| 4 Connect T24 or T15 Cross Tee, L=625 mm | 0,8m/m ² |
| 5 Connect Adjustable Hanger, installed at 1250 mm centres (max. distance from wall 600 mm) | 0,7/m ² |
| 6 Connect Hanger Clip (not to be used in swimming hall environments) | 0,7/m ² |
| 7 Connect Channel Trim, fixed c300 | as required |
| 8 Connect Hygiene Clip 20 | 10/m ² |
| 9 Connect Demo Clip 20 C4, (where access is needed) | as required |
| Δ Min. overall depth of system: 150 mm | - |
| δ Min. demounting depth: 150 mm | - |

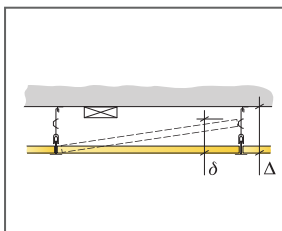

See Quantity Specification

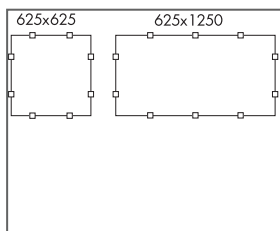

Arrangement of clips

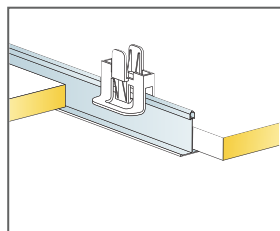

Connect Hygiene Clips for keeping tiles in position

| Size, mm | Max live load [N] | Min load bearing capacity [N] |
|------------|-------------------|-------------------------------|
| 625x625x20 | 35 | 160 |

Live load/load bearing capacity

Ecophon Hygiene Protec™ Ds

Ecophon Hygiene Protec™ Ds has a concealed grid and is particle repellent for clean rooms, where disinfection and/or cleaning is required on a regular basis. The fully sealed absorbers have low emission levels, ensuring high indoor air quality. They are resistant to mould and bacteria growth.



Pharma Labor/Vorbereitung, Greven, Germany

SYSTEM RANGE

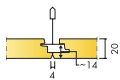

| | | |
|-----------------|---------|----------|
| Size, mm | 600x600 | 1200x600 |
| T24 | • | • |
| Thickness (THK) | 20 | 20 |
| Inst. Diagr. | M615 | M615 |

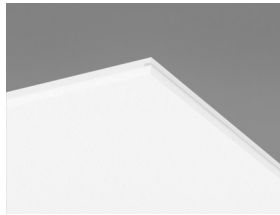

Hygiene Protec Ds tile

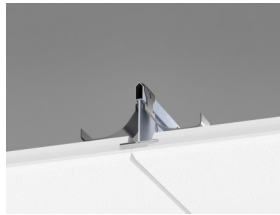

Hygiene Protec Ds C1 section with Connect Hold Down Clip Ds



Sealed junction with wall

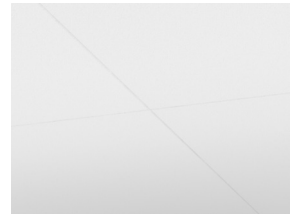

Hygiene Protec Ds C1 system

Acoustic



Sound Absorption:

Test results according to EN ISO 354. Classification according to EN ISO 11654, and the single value ratings for Noise Reduction Coefficient, NRC and Sound Absorption Average, SAA according to ASTM C 423.

α_p , Practical sound absorption coefficient

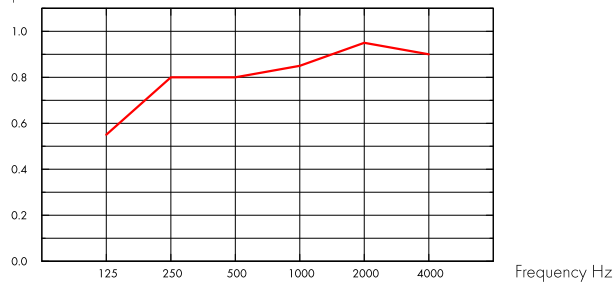

— Hygiene Protec Ds 20 mm, 200 mm o.d.s.
o.d.s = overall depth of system

| THK mm | o.d.s. mm | α_p , Practical sound absorption coefficient | | | | | | α_w | Sound absorption class |
|--------|-----------|---|--------|--------|---------|---------|---------|------------|------------------------|
| | | 125 Hz | 250 Hz | 500 Hz | 1000 Hz | 2000 Hz | 4000 Hz | | |
| 20 | 200 | 0.55 | 0.80 | 0.80 | 0.85 | 0.95 | 0.90 | 0.85 | B |

| THK mm | o.d.s. mm | NRC | SAA |
|--------|-----------|------|------|
| 20 | 200 | 0.85 | 0.85 |

Indoor Air Quality



| Certificate / Label | |
|------------------------------|----------|
| Eurofins Indoor Air Comfort® | IAC Gold |
| French VOC | A+ |



Cradle to Cradle Certified®



This product is Cradle to Cradle Certified® at Bronze level (version 4.0).



Material Health



This product has received a C2C Certified Material Health Certificate™ at the Silver level (standard version 4.0). The C2C Certified Material Health Certificate™ is a verification of the health and safety of a product's composition using the Material Health requirements of the Cradle-to-Cradle Certified Product Standard.



Carbon footprint

| kg CO ₂ equiv/m ² | | Life-cycle stages A1 to C4 from EPD, in conformity with ISO 14025 / EN 15804 |
|---|------|--|
| Hygiene Protec Ds | 7,06 | |



Circularity

| | |
|--|------------------|
| Minimum post-consumer recycled content | 47% |
| Recyclability | Fully recyclable |



Fire safety

| Country | Fire standard | Class | The glass wool core of the tiles is tested and classified as non-combustible according to EN ISO 1182. |
|---------|---------------|----------|--|
| Europe | EN 13501-1 | A2-s1,d0 | |



Humidity Resistance

Class C, relative humidity 95% and 30°C, according to EN 13964:2014



Visual appearance

White 500, nearest NCS colour sample S 0500-N, 84% light reflectance.



Cleanability

| Standard/Method | Frequency |
|-------------------------|-----------|
| Dusting | Daily |
| Wet wiping | Weekly |
| Steam cleaning | 4/year |
| Hydrogen peroxide vapor | • |



Surface Endurance

Product tested according to ISO 11998, and withstand 200 cycles.



Chemical resistance/Disinfection

| Chemical | Active Substance | Concentration | Tested according to ISO 11998 and withstand the following chemicals or disinfectants. |
|-------------|---|---------------|---|
| Ethanol | Ethanol | 70% | |
| Chlorine | Sodium Hypochlorite solution | 2,5% | |
| Virkon S | Dipotassium peroxodisulphate; Sulphamic acid | 1% | |
| Isopropanol | Isopropyl Alcohol | 70% | |



Mould and Bacterial Resistance

| Standard/Method | Class |
|--|------------------------------------|
| ISO 846 :2019 method C (for bacterium) | 0 (No growth under the microscope) |
| ASTM D3273-16 (for fungi) | 10 (0% growth on the surface) |



Clean Room

| Standard/Method | Class |
|-----------------|---|
| ISO 14644 | Particle cleanliness class ISO 3 |
| NF S 90-351 | Microbiological class M1/area 4 |
| NF S 90-351 | Particle elimination kinetics CP(0,5) 1 |



Accessibility

The tiles are demountable.



Installation

Installed according to installation diagrams, installation guides and drawing aid. Cut panels must be sealed with Connect Edge sealant.



System weight

| | kg/m ² | Weight information is indicative and subject to variation. |
|---|-------------------|--|
| Hygiene Protec Ds | 2,9 | |
| Hygiene Protec Ds + Connect grid system | 3,8 | |



Mechanical properties

See table about Max live load and Min load bearing capacity and Functional demands, Mechanical properties at www.ecophon.com.



CE

Ecophon ceiling systems are CE marked according to the European harmonized standard EN13964:2014. CE marked construction products are covered by a Declaration of Performance (DOP) which enables customers and users to easily compare performance of products available on the European market.

INSTALLATION DIAGRAM (M615) FOR ECOPHON HYGIENE PROTECT™ DS. SUSPENDED INSTALLATION

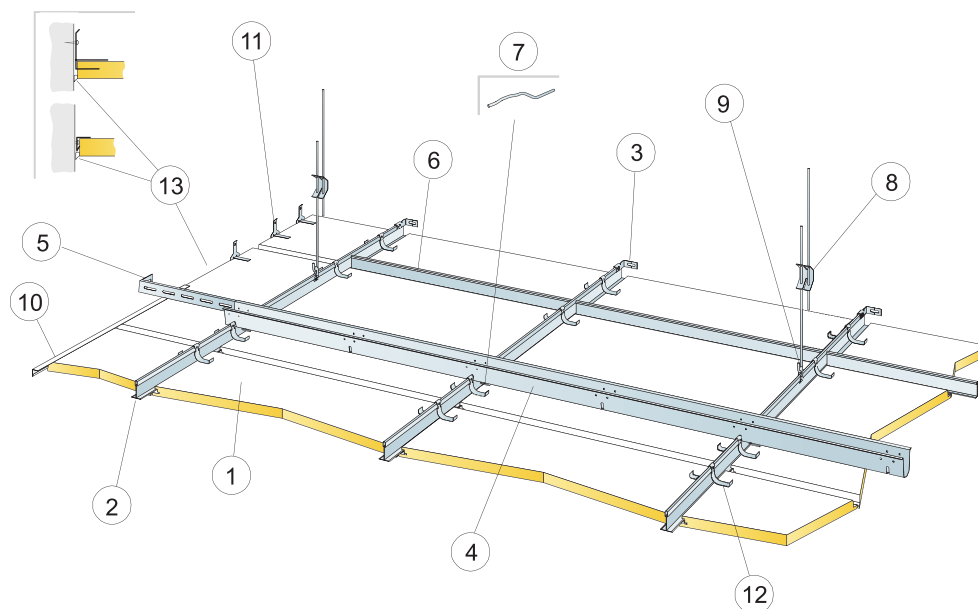

© Saint-Gobain Ecophon AB

QUANTITY SPECIFICATION (EXCL. WASTAGE)

| | Size, mm | |
|--|----------------------------------|----------------------------------|
| | 600x600 | 1200x600 |
| 1 Hygiene Protec Ds | 2,8/m ² | 1,4/m ² |
| 2 Connect T24 Main Runner Pl, installed at 600 mm centres | 1,7m/m ² | 1,7m/m ² |
| 3 Connect Wall Bracket for T-profiles | 1/suspended row of Main runner | |
| 4 Connect Space Bar, installed at 1500 mm centres (max. distance from wall 300 mm) | 0,7m/m ² | 0,7m/m ² |
| 5 Connect Wall Bracket, L=700 mm, for Connect Space Bar | 1/row of Space bar | |
| 6 Connect T24 Cross Tee, L=600 mm | 2/row of Main runner | |
| 7 Connect Space Bar Winch, installed one per joint Connect Main Runner/Connect Space Bar | 1,4/m ² | 1,4/m ² |
| 8 Connect Adjustable Hanger, installed at 1200 mm centres (max. distance from wall 600 mm) | 0,7/m ² | 0,7/m ² |
| 9 Connect Hanger Clip (not to be used in swimming hall environments) | 0,7/m ² | 0,7/m ² |
| 10 Alt. Connect Frieze Trim, fixed c300 mm | as required | as required |
| 11 Connect Frieze Bracket, installed at 500 mm centre. Minimum free depth above tile 150 mm. | 2/cut tile with one bearing edge | 3/cut tile with one bearing edge |
| 12 Connect Hold Down Clip Ds | 2/tile, 50-100 mm from corners | 3/tile, 50-100 mm from corners |
| 13 Joint sealant (not supplied by Ecophon) | as required | as required |
| Δ Min. overall depth of system: 170 mm | - | - |
| δ Min. demounting depth: 30 mm | - | - |

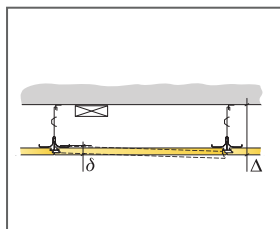

See Quantity Specification

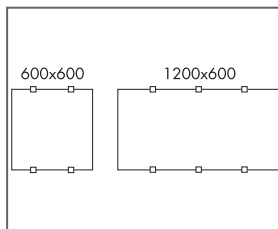

Arrangement of clips

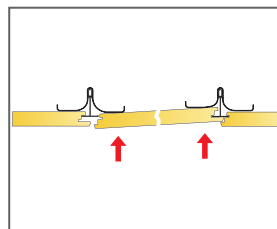

Demounting of tile from below

| Size, mm | Max live load [N] | Min load bearing capacity [N] |
|-------------|-------------------|-------------------------------|
| 600x600x20 | 30 | 160 |
| 1200x600x20 | 30 | 160 |

Live load/load bearing capacity



Ecophon Hygiene Protec™ Air A

Ecophon Hygiene Protec™ Air A has an exposed grid and are particle repellent for clean rooms, where disinfection and/or cleaning is required on a regular basis. Suitable for areas requiring air-pressure control. They are resistant to mould and bacteria growth and withstand HPV cleaning.



SYSTEM RANGE

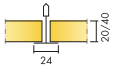

| | | | | |
|-----------------|---------|---------|----------|----------|
| Size, mm | 600x600 | 600x600 | 1200x600 | 1200x600 |
| T24 | • | • | • | • |
| Thickness (THK) | 20 | 40 | 20 | 40 |
| Inst. Diagr. | M469 | M469 | M469 | M469 |

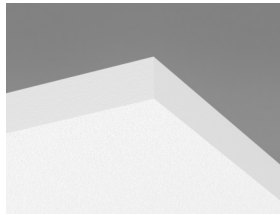

Hygiene Protec Air A tile

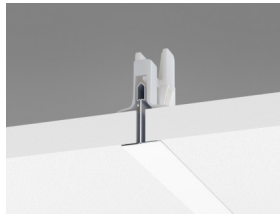

Hygiene Protec Air A C1 section with Connect Hygiene Clip 20



Hygiene Protec Air A system

Acoustic



Sound Absorption:

Test results according to EN ISO 354. Classification according to EN ISO 11654.

α_p , Practical sound absorption coefficient

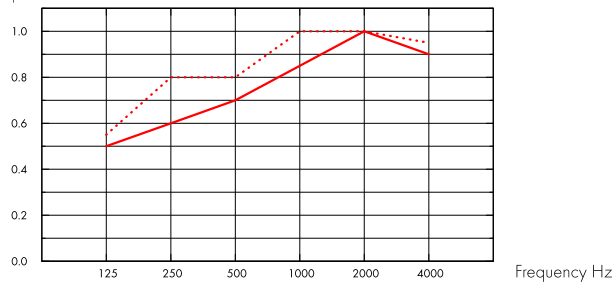

— Hygiene Protec Air A 20 mm, 200 mm o.d.s.

⋯ Hygiene Protec Air A 40 mm, 200 mm o.d.s.

o.d.s = overall depth of system

| THK mm | o.d.s. mm | α_p , Practical sound absorption coefficient | | | | | | α_w | Sound absorption class |
|--------|-----------|---|--------|--------|---------|---------|---------|------------|------------------------|
| | | 125 Hz | 250 Hz | 500 Hz | 1000 Hz | 2000 Hz | 4000 Hz | | |
| 20 | 200 | 0.50 | 0.60 | 0.70 | 0.85 | 1.00 | 0.90 | 0.80 | B |
| 40 | 200 | 0.55 | 0.80 | 0.80 | 1.00 | 1.00 | 0.95 | 0.90 | A |

| THK mm | o.d.s. mm | NRC | SAA |
|--------|-----------|------|------|
| 20 | 200 | 0.80 | 0.81 |
| 40 | 200 | 0.90 | 0.92 |

Indoor Air Quality



Certificate / Label

Eurofins Indoor Air Comfort®

IAC Gold

French VOC

A+



Carbon footprint



kg CO₂ equiv/m²

Hygiene Protec Air A

4,45

Life-cycle stages A1 to C4 from EPD, in conformity with ISO 14025 / EN 15804

Circularity



Minimum post-consumer recycled content

38%

Recyclability

Fully recyclable



Fire safety

| Country | Fire standard | Class |
|---------|---------------|----------|
| Europe | EN 13501-1 | A2-s1,d0 |

The glass wool core of the tiles is tested and classified as non-combustible according to EN ISO 1182.



Humidity Resistance

Class C, relative humidity 95% and 30°C, according to EN 13964:2014



Visual appearance

White 500, nearest NCS colour sample S 0500-N, 84% light reflectance.



Cleanability

| Standard/Method | Frequency |
|-------------------------|-----------|
| Dusting | Daily |
| Wet wiping | Weekly |
| Steam cleaning | 4/year |
| Hydrogen peroxide vapor | • |



Surface Endurance

Product tested according to ISO 11998, and withstand 200 cycles.



Chemical resistance/Disinfection

| Chemical | Active Substance | Concentration |
|-------------|---|---------------|
| Ethanol | Ethanol | 70% |
| Chlorine | Sodium Hypochlorite solution | 2,5% |
| Virkon S | Dipotassium peroxodisulphate; Sulphamidic acid | 1% |
| Isopropanol | Isopropyl Alcohol | 70% |

Tested according to ISO 11998 and withstand the following chemicals or disinfectants.



Mould and Bacterial Resistance

| Standard/Method | Class |
|--|------------------------------------|
| ISO 846 :2019 method C (for bacterium) | 0 (No growth under the microscope) |
| ASTM D3273-16 (for fungi) | 10 (0% growth on the surface) |



Clean Room

| Standard/Method | Class |
|-----------------|--|
| ISO 14644 | Particle cleanliness class ISO 3 |
| NF S 90-351 | Microbiological class M1/area 4 |
| NF S 90-351 | Particle elimination kinetics CP(0,5) 1 |



Air permeability

| Protec Air A 20 mm | Positive pressure m ³ /(h x m ²) | Negative pressure m ³ /(h x m ²) | Positive pressure L/s/m ² | Negative pressure L/s/m ² | Protec Air A 40 mm | Positive pressure m ³ /(h x m ²) | Negative pressure m ³ /(h x m ²) | Positive pressure L/s/m ² | Negative pressure L/s/m ² | Air leak rate measured at positive respective negative room pressure up to 50 Pa (Q50) EN ISO 9972 :2015 |
|--------------------|---|---|--------------------------------------|--------------------------------------|--------------------|---|---|--------------------------------------|--------------------------------------|--|
| 10 (Pa) | 16,1 | 15,0 | 4,0 | 4,2 | 10 (Pa) | 14,6 | 16,9 | 4,0 | 4,7 | |
| 20 (Pa) | 27,9 | 22,1 | 7,8 | 6,1 | 20 (Pa) | 25,7 | 26,5 | 7,1 | 7,4 | |
| 30 (Pa) | 38,5 | 27,7 | 10,7 | 7,7 | 30 (Pa) | 35,8 | 34,4 | 9,9 | 9,6 | |
| 40 (Pa) | 48,4 | 32,5 | 13,4 | 9,0 | 40 (Pa) | 45,2 | 41,4 | 12,6 | 11,5 | |
| 50 (Pa) /Q50 | 57,8 | 36,8 | 16,1 | 10,2 | 50 (Pa) /Q50 | 54,3 | 47,8 | 15,1 | 13,3 | |



Accessibility

The tiles are demountable. Minimum demounting depth according to installation diagram. The tiles are secured using clips to allow for effective cleaning. The clips are easily removable from above the ceiling. An easy-to-open Connect Inspection hatch is available to simplify access to the ceiling void.



Installation

Installed according to installation diagrams, installation guides and drawing aid. Cut panels must be sealed with Connect Edge sealant.



System weight

| | kg/m ² | Weight information is indicative and subject to variation. |
|--|-------------------|--|
| Hygiene Protec Air A 20 mm | 2,0 | |
| Hygiene Protec Air A 20 mm + Connect grid system | 3,0 | |
| Hygiene Protec Air A 40 mm | 3,0 | |
| Hygiene Protec Air A 40 mm + Connect grid system | 4,0 | |



Mechanical properties

See table about Max live load and Min load bearing capacity and Functional demands, Mechanical properties at www.ecophon.com.



CE

Ecophon ceiling systems are CE marked according to the European harmonized standard EN13964:2014. CE marked construction products are covered by a Declaration of Performance (DOP) which enables customers and users to easily compare performance of products available on the European market.

INSTALLATION DIAGRAM (M469) FOR ECOPHON HYGIENE PROTECT™ AIR A

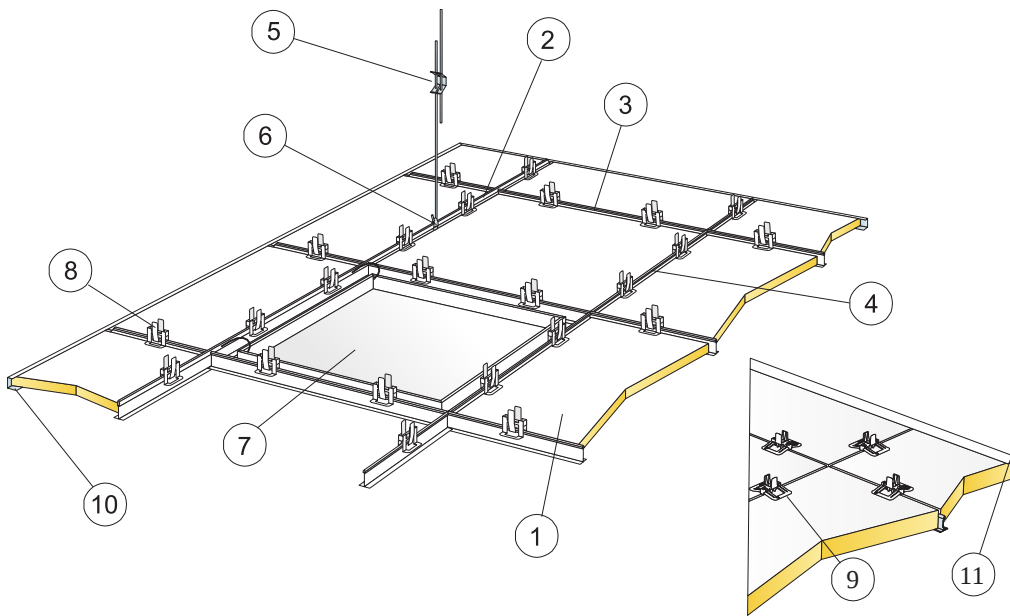

© Saint-Gobain Ecophon AB

QUANTITY SPECIFICATION (EXCL. WASTAGE)

| | Size, mm | |
|--|---------------------|---------------------|
| | 600x600 | 1200x600 |
| 1 Hygiene Protec Air A | 2,8/m ² | 1,4/m ² |
| 2 Connect T24 Main Runner, installed at 1200 mm centres | 0,9m/m ² | 0,9m/m ² |
| 3 Connect T24 Cross Tee, L=1200 mm, installed at 600 mm centres | 1,7m/m ² | 1,7m/m ² |
| 4 Connect T24 Cross Tee, L=600 mm | 0,9m/m ² | - |
| 5 Connect Adjustable Hanger, installed at 1200 mm centres (max. distance from wall 600 mm) | 0,7/m ² | 0,7/m ² |
| 6 Connect Hanger Clip (not to be used in swimming hall environments) | 0,7/m ² | 0,7/m ² |
| 7 Connect Inspection Hatch C3 | as required | as required |
| 8 Connect Hygiene Clip 20 | 11/m ² | 7/m ² |
| 9 Connect Hygiene Clip 40 | 11/m ² | 7/m ² |
| 10 Connect Channel Trim, fixed c300 (for 20 mm thickness) | as required | as required |
| 11 Connect Channel Trim, fixed c300 (for 40 mm thickness) | as required | as required |
| Connect Edge Sealant | as required | as required |
| Δ Min. overall depth of system: 150 mm | - | - |
| δ Min. demounting depth 20 mm: 150 mm | - | - |
| δ Min. demounting depth 40 mm: 170 mm | - | - |



See Quantity Specification

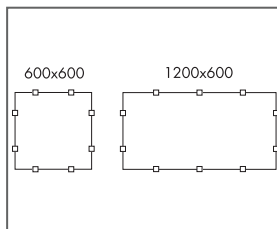

Arrangement of clips

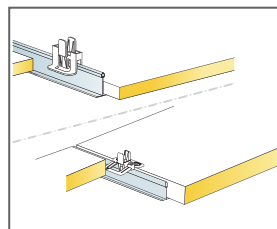

Clip for keeping tiles in place for 40 mm tiles

| Size, mm | Max live load [N] | Min load bearing capacity [N] |
|-------------|-------------------|-------------------------------|
| 600x600x20 | 50 | 160 |
| 600x600x40 | 50 | 160 |
| 1200x600x20 | 50 | 160 |
| 1200x600x40 | 50 | 160 |

Live load/load bearing capacity



Ecophon Hygiene Performance™ A

Ecophon Hygiene Performance™ A is suitable for humid areas and withstands advanced cleaning, such as steam and high/low pressure washing on a regular basis. The surface is resistant to common detergents and disinfectants.



SYSTEM RANGE

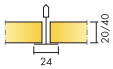

| | | | | |
|-----------------|----------------|----------------|----------------|----------------|
| Size, mm | 600x600 | 600x600 | 1200x600 | 1200x600 |
| T24 | • | • | • | • |
| Thickness (THK) | 20 | 40 | 20 | 40 |
| Inst. Diag. | M395C3, M266C4 | M395C3, M266C4 | M395C3, M266C4 | M395C3, M266C4 |



Hygiene Performance A tile

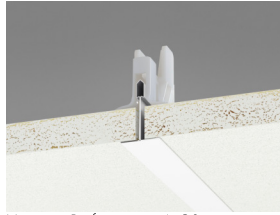

Hygiene Performance A C3 section with Connect Hygiene clip 20



Hygiene Performance A system

Acoustic



Sound Absorption:

Test results according to EN ISO 354. Classification according to EN ISO 11654.

α_p , Practical sound absorption coefficient

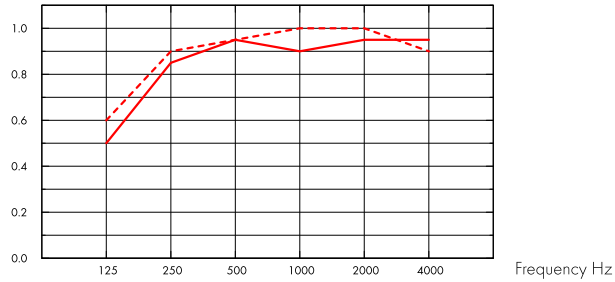

— Hygiene Performance A 20 mm, 200 mm o.d.s.

- - - Hygiene Performance A 40 mm, 200 mm o.d.s.

o.d.s = overall depth of system

| THK mm | o.d.s. mm | α_p , Practical sound absorption coefficient | | | | | | α_w | Sound absorption class |
|-----------|-----------|---|--------|--------|---------|---------|---------|------------|------------------------|
| | | 125 Hz | 250 Hz | 500 Hz | 1000 Hz | 2000 Hz | 4000 Hz | | |
| 20 | 200 | 0.50 | 0.85 | 0.95 | 0.90 | 0.95 | 0.95 | A | |
| 40 | 200 | 0.60 | 0.90 | 0.95 | 1.00 | 1.00 | 1.00 | A | |

| THK mm | o.d.s. mm | NRC | SAA |
|-----------|-----------|------|------|
| 20 | 200 | 0.90 | 0.92 |
| 40 | 200 | 0.95 | 0.96 |

Indoor Air Quality



| Certificate / Label | |
|------------------------------|----------|
| Eurofins Indoor Air Comfort® | IAC Gold |
| French VOC | A+ |



Cradle to Cradle Certified®



This product is Cradle to Cradle Certified® at Bronze level (version 4.0).



Material Health



This product has received a C2C Certified Material Health Certificate™ at the Silver level (standard version 4.0). The C2C Certified Material Health Certificate™ is a verification of the health and safety of a product's composition using the Material Health requirements of the Cradle-to-Cradle Certified Product Standard.



Carbon footprint

| | kg CO ₂ equiv/m ² |
|-----------------------------|---|
| Hygiene Performance A 20 mm | 2,56 |
| Hygiene Performance A 40 mm | 4,22 |

Life-cycle stages A1 to C4 from EPD, in conformity with ISO 14025 / EN 15804



Circularity

| | |
|--|------------------|
| Minimum post-consumer recycled content | 47% |
| Recyclability | Fully recyclable |



Fire safety

| Country | Fire standard | Class |
|---------|---------------|----------|
| Europe | EN 13501-1 | A2-s1,d0 |

The glass wool core of the tiles is tested and classified as non-combustible according to EN ISO 1182.



Humidity Resistance

Class D, relative humidity 97% and 50°C, according to EN 13964:2014



Visual appearance

White 500, nearest NCS colour sample S 0500-N, 84% light reflectance.



Cleanability

| Standard/Method | Frequency |
|-------------------------|-----------|
| Dusting | Daily |
| Wet wiping | Weekly |
| Steam cleaning | 4/year |
| Low pressure cleaning | 2/year |
| High pressure cleaning | 2/year |
| Hydrogen peroxide vapor | • |



Surface Endurance

Product tested according to ISO 11998, and withstand 200 cycles.



Chemical resistance/Disinfection

| Chemical | Active Substance | Concentration |
|------------------|--|---------------|
| Actichlor plus | NaDCC (Sodium Dichloroisocyanurate) | 1% |
| LifeClean | Chlorine dioxide | Undiluted |
| Etanol | Etanol | 70% |
| Chlorine | Sodium Hypochlorite solution | 2,5% |
| Virkon S | Dipotassium peroxodisulphate; Sulphamidic acid | 1% |
| Isopropanol | Isopropyl Alcohol | 70% |
| Oxivir Excel | Hydrogen peroxide | 0,5% |
| Sumabac D10 | Quaternary ammonium compound, Sodium carbonate | 1% |
| Suredis VT1 | n-(3-aminopropyl)-n-dodecylpropan-1,3-diamin | 1% |
| Enduro Chlor VE5 | Potassium hydroxide | 1,5% |
| Acipusfoam VF59 | Nitric Acid | 5% |

Tested according to ISO 11998 and withstands the following chemicals or disinfectants.



Mould and Bacterial Resistance

| Standard/Method | Class |
|--|------------------------------------|
| ISO 846 :2019 method C (for bacterium) | 0 (No growth under the microscope) |
| ASTM D3273-16 (for fungi) | 10 (0% growth on the surface) |



Clean Room

| | Standard/Method | Class |
|-------------|-------------------------------|-----------|
| ISO 14644 | Particle cleanliness class | ISO 4 |
| NF S 90-351 | Microbiological class | M1/area 4 |
| NF S 90-351 | Particle elimination kinetics | CP{0,5} 5 |



Accessibility

The tiles are demountable. Minimum demounting depth according to installation diagram. The tiles are secured using clips to allow for effective cleaning. The clips are easily removable from above the ceiling. An easy-to-open Connect Inspection hatch is available to simplify access to the ceiling void.



Installation

Installed according to installation diagrams, installation guides and drawing aid. Cut panels must be sealed with Connect Edge sealant. Penetrations must be sealed with a suitable sealant.



System weight

| | kg/m ² |
|---|-------------------|
| Hygiene Performance A 20 mm | 1,6 |
| Hygiene Performance A 20 mm + Connect grid system | 2,6 |
| Hygiene Performance A 40 mm | 2,6 |
| Hygiene Performance A 40 mm + Connect grid system | 3,6 |

Weight information is indicative and subject to variation.



Mechanical properties

See table about Max live load and Min load bearing capacity and Functional demands, Mechanical properties at www.ecophon.com.



CE

Ecophon ceiling systems are CE marked according to the European harmonized standard EN13964:2014. CE marked construction products are covered by a Declaration of Performance (DOP) which enables customers and users to easily compare performance of products available on the European market.

INSTALLATION DIAGRAM (M395) FOR ECOPHON HYGIENE PERFORMANCE™ A C3

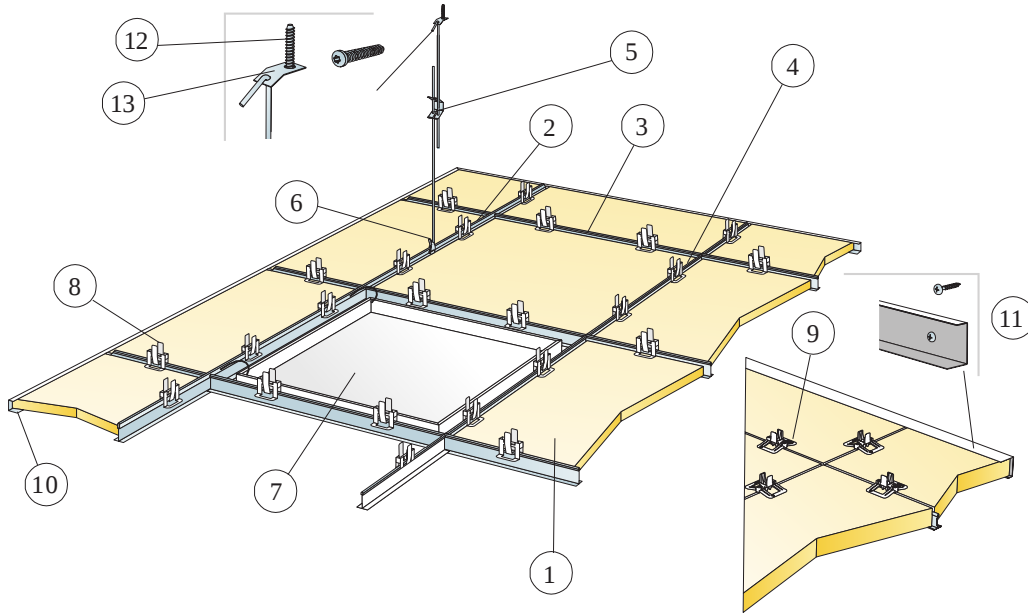

© Saint-Gobain Ecophon AB

QUANTITY SPECIFICATION (EXCL. WASTAGE)

| | Size, mm | |
|--|---------------------|---------------------|
| | 600x600 | 1200x600 |
| 1 Hygiene Performance A | 2,8/m ² | 1,4/m ² |
| 2 Connect T24 Main Runner C3, installed at 1200 mm centres | 0,9m/m ² | 0,9m/m ² |
| 3 Connect T24 Cross Tee C3, L=600 mm | 0,9m/m ² | - |
| 4 Connect T24 Cross Tee C3, L=1200 mm, installed at 600 mm centres | 1,7m/m ² | 1,7m/m ² |
| 5 Connect Adjustable Hanger C3, c 1200 (max distance from wall 600 mm) | 0,7/m ² | 0,7/m ² |
| 6 Connect Hanger Clip (not to be used in swimming hall environments) | 0,7/m ² | 0,7/m ² |
| 7 Connect Inspection Hatch C3 | as required | as required |
| 8 Connect Hygiene Clip 20 | 11/m ² | 7/m ² |
| 9 Connect Hygiene Clip 40 | 11/m ² | 7/m ² |
| 10 Connect Channel Trim C3, fixed c300 (for 20 mm thickness) | as required | as required |
| 11 Connect Channel Trim C3, fixed c300 (for 40 mm thickness) | as required | as required |
| 12 Connect Anchor Screw C4 | 0,7/m ² | 0,7/m ² |
| 13 Connect Fixing Plate C4 | 0,7/m ² | 0,7/m ² |
| Δ Min. overall depth of system: 150 mm | - | - |
| δ Min. demounting depth 20 mm: 150 mm | - | - |
| δ Min. demounting depth 40 mm: 170 mm | - | - |

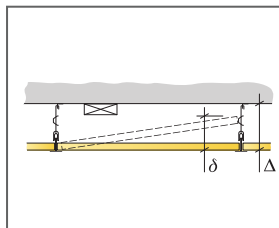

See Quantity Specification

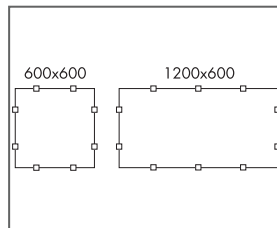

Arrangement of clips

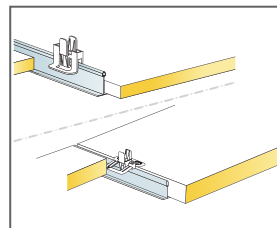

Clip for keeping tiles in place for 40 mm tiles

| Size, mm | Max live load [N] | Min load bearing capacity [N] |
|-------------|-------------------|-------------------------------|
| 600x600x20 | 50 | 160 |
| 600x600x40 | 50 | 160 |
| 1200x600x20 | 50 | 160 |
| 1200x600x40 | 50 | 160 |

Live load/load bearing capacity

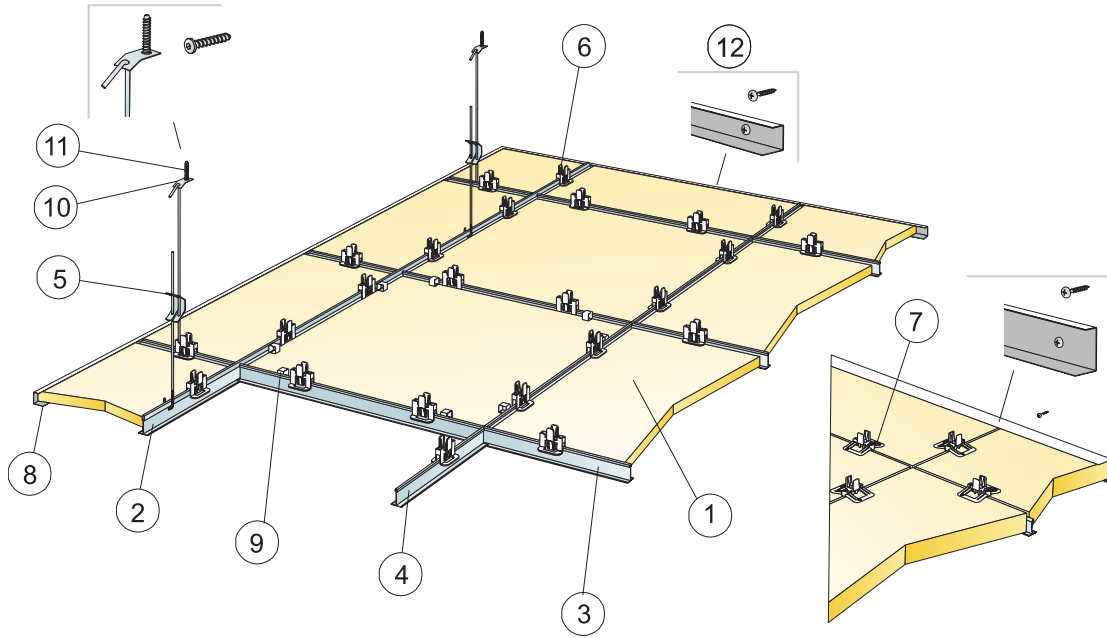

© Saint-Gobain Ecophon AB

QUANTITY SPECIFICATION (EXCL. WASTAGE)

| | Size, mm | |
|--|------------------------|---------------------|
| | 600x600 | 1200x600 |
| 1 Hygiene Performance A | 2,8/m ² | 1,4/m ² |
| 2 Connect T24 Main Runner C4, c1200 | 0,9m/m ² | 0,9m/m ² |
| 3 Connect T24 Cross Tee C4, l=1200, c600 | 1,7m/m ² | 1,7m/m ² |
| 4 Connect T24 Cross Tee C4, l=600 | 0,9m/m ² | - |
| 5 Connect Adjustable Hanger C4, c1200, (max 600 mm distance from wall) | 0,7/m ² | 0,7/m ² |
| 6 Connect Hygiene Clip 20 | 11/m ² | 7/m ² |
| 7 Connect Hygiene Clip 40 C4 | 11/m ² | 7/m ² |
| 8 Connect Channel Trim C4, fixed at c300 mm | as required | as required |
| 9 Connect Demo Clip 20 C4, (where access is needed) | as required | as required |
| 10 Connect Fixing Plate C4 | 0,7/m ² | 0,7/m ² |
| 11 Connect Anchor Screw C4 | 0,7/m ² | 0,7/m ² |
| 12 Connect Installation Screw C4 | 3,4/lm Channel trim C4 | |
| Δ Min. overall depth of system: 150 mm | - | - |
| δ Min. demounting depth: 150 mm | - | - |
| δ Min. demounting depth 40 mm: 170 mm | - | - |

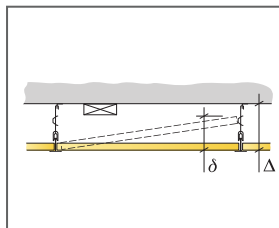

See Quantity Specification

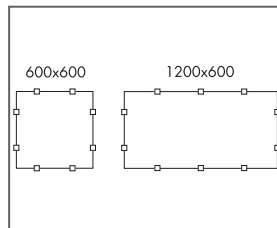

Arrangement of clips

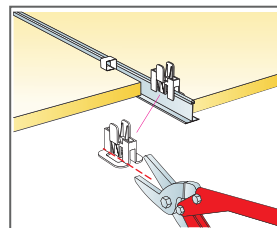

Cutting of Connect Hygiene Clip 20 at the inspection tile

| Size, mm | Max live load [N] | Min load bearing capacity [N] |
|-------------|-------------------|-------------------------------|
| 600x600x20 | 50 | 160 |
| 600x600x40 | 50 | 160 |
| 1200x600x20 | 50 | 160 |
| 1200x600x40 | 50 | 160 |

Live load/load bearing capacity



Ecophon Hygiene Performance™ B

Ecophon Hygiene Performance™ B is bonded edge-to-edge to the soffit surface, creating a ceiling with a smooth appearance. The bevelled edge creates a narrow groove between each tile. For applications where the minimum possible overall depth of system is required. Product endure abrasive wet wiping and advanced cleaning such as steam cleaning on a regular basis.



SYSTEM RANGE

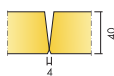

| | | |
|-----------------|---------|----------|
| Size, mm | 600x600 | 1200x600 |
| Direct | • | • |
| Thickness (THK) | 40 | 40 |
| Inst. Diagr. | M638 | M638 |

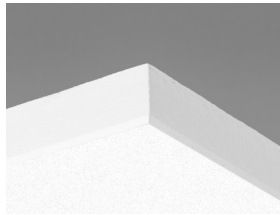

Hygiene Performance B tile

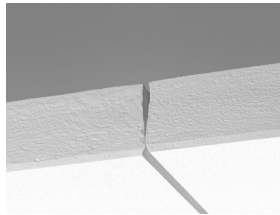

Section of Hygiene Performance B system

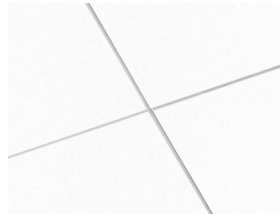

Hygiene Performance B system

Acoustic



Sound Absorption:

Test results according to EN ISO 354. Classification according to EN ISO 11654, and the single value ratings for Noise Reduction Coefficient, NRC and Sound Absorption Average, SAA according to ASTM C 423.

α_p , Practical sound absorption coefficient

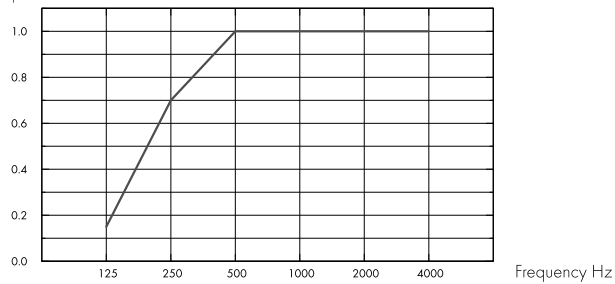

– Performance B, 43mm o.d.s.
o.d.s = overall depth of system

| THK mm | o.d.s. mm | α_p , Practical sound absorption coefficient | | | | | | α_w | Sound absorption class |
|-----------|-----------|---|--------|--------|---------|---------|---------|------------|------------------------|
| | | 125 Hz | 250 Hz | 500 Hz | 1000 Hz | 2000 Hz | 4000 Hz | | |
| 40 | 43 | 0.15 | 0.70 | 1.00 | 1.00 | 1.00 | 1.00 | 1.00 | A |

| THK mm | o.d.s. mm | NRC | SAA |
|-----------|-----------|------|------|
| 40 | 43 | 0.95 | 0.95 |

Indoor Air Quality



| Certificate / Label | |
|------------------------------|----------|
| Eurofins Indoor Air Comfort® | IAC Gold |
| French VOC | A+ |



Circularity



| | |
|--|------------------|
| Minimum post-consumer recycled content | 57% |
| Recyclability | Fully recyclable |

Fire safety



| Country | Fire standard | Class |
|---------|---------------|----------|
| Europe | EN 13501-1 | A2-s1,d0 |

The glass wool core of the tiles is tested and classified as non-combustible according to EN ISO 1182.



Humidity Resistance

Classification

Class C, RH 95% and 30°C



Visual appearance

White 500, nearest NCS colour sample S 0500-N, 84% light reflectance.



Cleanability

| Standard/Method | Frequency |
|-------------------------|-----------|
| Dusting | Daily |
| Wet wiping | Weekly |
| Steam cleaning | 4/year |
| Hydrogen peroxide vapor | • |



Surface Endurance

Product tested according to ISO 11998, and withstand 200 cycles.



Chemical resistance/Disinfection

| Chemical | Active Substance | Concentration |
|------------------|--|---------------|
| Actichlor plus | NaDCC (Sodium Dichloroisocyanurate) | 1% |
| LifeClean | Chlorine dioxide | Undiluted |
| Etanol | Etanol | 70% |
| Chlorine | Sodium Hypochlorite solution | 2,5% |
| Virkon S | Dipotassium peroxodisulphate; Sulphamidic acid | 1% |
| Isopropanol | Isopropyl Alcohol | 70% |
| Oxivir Excel | Hydrogen peroxide | 0,5% |
| Sumabac D10 | Quaternary ammonium compound, Sodium carbonate | 1% |
| Suredis VT1 | n-(3-aminopropyl)-n-dodecylpropan-1,3-diamin | 1% |
| Enduro Chlor VE5 | Potassium hydroxide | 1,5% |
| Acipusfoam VF59 | Nitric Acid | 5% |

Tested according to ISO 11998 and withstands the following chemicals or disinfectants.



Mould and Bacterial Resistance

| Standard/Method | Class |
|--|------------------------------------|
| ISO 846 :2019 method C (for bacterium) | 0 (No growth under the microscope) |
| ASTM D3273-16 (for fungi) | 10 (0% growth on the surface) |



Clean Room

| Standard/Method | Class |
|-----------------|---|
| ISO 14644 | Particle cleanliness class ISO 4 |
| NF S 90-351 | Microbiological class M1/area 4 |
| NF S 90-351 | Particle elimination kinetics CP(0,5) 5 |



Accessibility

The tiles are not demountable.



Installation

Installed according to installation diagrams, installation guides and drawing aid. Cut panels must be sealed with Connect Edge sealant. Penetrations must be sealed with a suitable sealant.



System weight

| | kg/m ² | Weight information is indicative and subject to variation. |
|-----------------------|-------------------|--|
| Hygiene Performance B | 3,7 | |



Mechanical properties

Additional live load has to be fixed to the soffit.



CE

Ecophon ceiling systems are CE marked according to the European harmonized standard EN13964:2014. CE marked construction products are covered by a Declaration of Performance (DOP) which enables customers and users to easily compare performance of products available on the European market.

INSTALLATION DIAGRAM (M638) FOR ECOPHON HYGIENE PERFORMANCE B, WITH GLUE

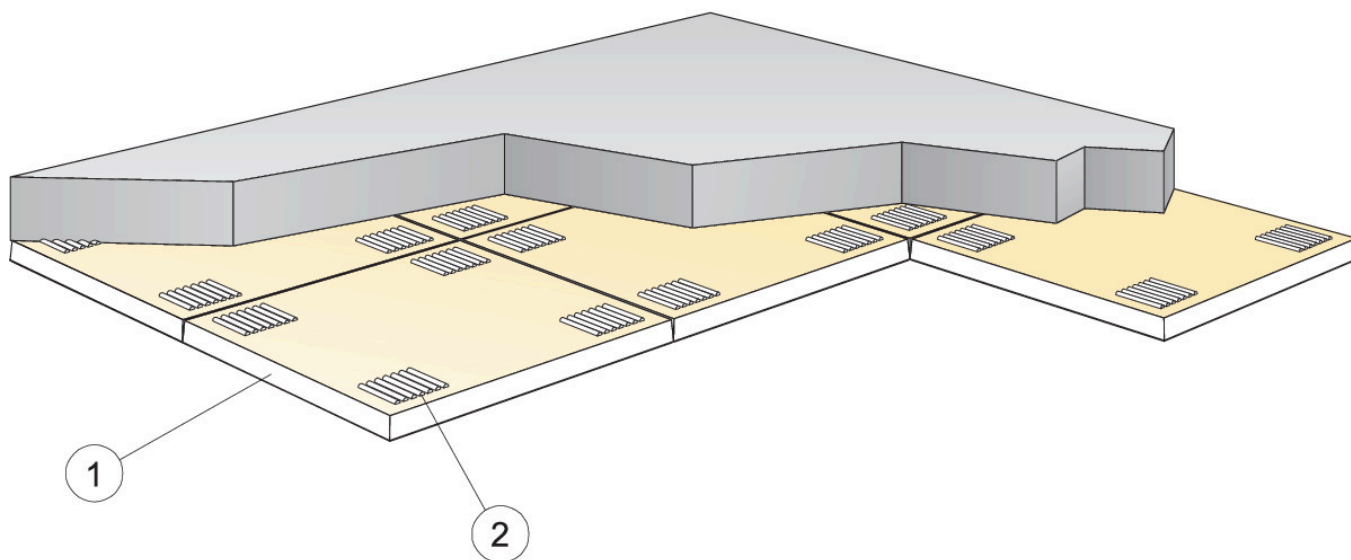

© Saint-Gobain Ecophon AB

QUANTITY SPECIFICATION (EXCL. WASTAGE)

| | Size, mm | |
|---|--------------------|--------------------|
| | 600x600 | 1200x600 |
| 1 Hygiene Performance™ B | 2,8/m ² | 1,4/m ² |
| 2 Connect Absorber glue (0,25 l/m ² - 0,4 l/m ² depending on installation conditions) | as required | as required |
| Use Connect Notched spatula to apply the glue. | - | - |
| Δ Min. overall depth of system: 43 mm | - | - |
| δ Min. demounting depth: The system is not demountable | - | - |
| Visible edges should be painted | - | - |

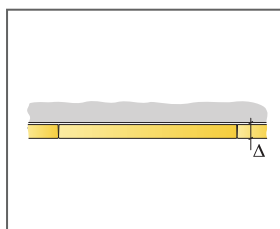

See Quantity specification

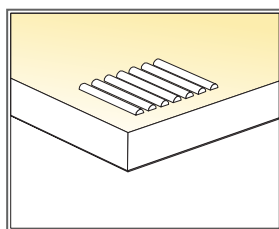

Application of glue

| Size, mm | Max live load [N] | Min load bearing capacity [N] |
|-------------|-------------------|-------------------------------|
| 600x600x40 | - | - |
| 1200x600x40 | - | - |

Live load/load bearing capacity



Ecophon Hygiene Performance™ Ds

Ecophon Hygiene Performance™ Ds is a suspended ceiling with a concealed grid, where individual tiles must be easily demountable. Suitable for swimming pool areas, it's compatible in areas with high humidity, corrosivity and occasional direct water.



SYSTEM RANGE

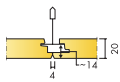

| | | |
|-----------------|---------|----------|
| Size, mm | 600x600 | 1200x600 |
| T24 | • | • |
| Thickness (THK) | 20 | 20 |
| Inst. Diagr. | M616C4 | M616C4 |

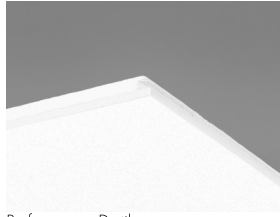

Performance Ds tile

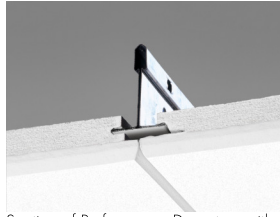

Section of Performance Ds system with Connect T24 Main Runner C4

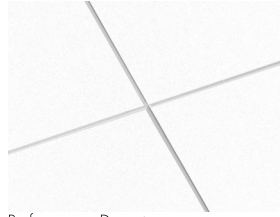

Performance Ds system



The individual tiles are easily demountable

Acoustic



Sound Absorption:

Test results according to EN ISO 354. Classification according to EN ISO 11654, and the single value ratings for Noise Reduction Coefficient, NRC and Sound Absorption Average, SAA according to ASTM C 423.

α_p , Practical sound absorption coefficient

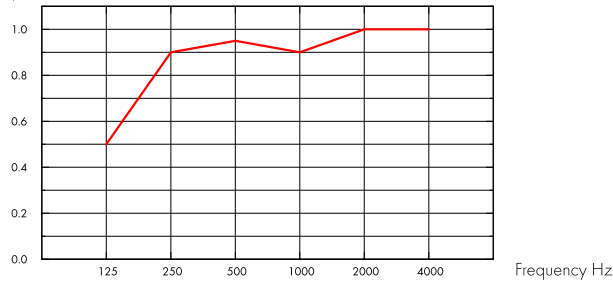

— Hygiene Performance Ds 20 mm, 200 mm o.d.s.

o.d.s = overall depth of system

| THK mm | o.d.s. mm | α_p , Practical sound absorption coefficient | | | | | | α_w | Sound absorption class |
|--------|-----------|---|--------|--------|---------|---------|---------|------------|------------------------|
| | | 125 Hz | 250 Hz | 500 Hz | 1000 Hz | 2000 Hz | 4000 Hz | | |
| 20 | 200 | 0.50 | 0.90 | 0.95 | 0.90 | 1.00 | 1.00 | 0.95 | A |

| THK mm | o.d.s. mm | NRC | SAA |
|--------|-----------|------|------|
| 20 | 200 | 0.95 | 0.95 |

Indoor Air Quality



| Certificate / Label | |
|------------------------------|----------|
| Eurofins Indoor Air Comfort® | IAC Gold |
| French VOC | A+ |



Carbon footprint



| | kg CO ₂ equiv/m ² | Life-cycle stages A1 to C4 from EPD, in conformity with ISO 14025 / EN 15804 |
|--------------------------------------|---|--|
| Hygiene Performance Ds (EN 15804+A2) | 3,46 | |

Circularity



| | |
|--|------------------|
| Minimum post-consumer recycled content | 51% |
| Recyclability | Fully recyclable |



Fire safety

| Country | Fire standard | Class |
|---------|---------------|----------|
| Europe | EN 13501-1 | A2-s1,d0 |

The glass wool core of the tiles is tested and classified as non-combustible according to EN ISO 1182.



Humidity Resistance

Class C, relative humidity 95% and 30°C, according to EN 13964:2014



Visual appearance

White 500, nearest NCS colour sample S 0500-N, 84% light reflectance.



Cleanability

| Standard/Method | Frequency |
|-------------------------|-----------|
| Dusting | Daily |
| Wet wiping | Weekly |
| Steam cleaning | 4/year |
| Hydrogen peroxide vapor | • |



Surface Endurance

Product tested according to ISO 11998, and withstand 200 cycles.



Chemical resistance/Disinfection

| Chemical | Active Substance | Concentration |
|------------------|--|---------------|
| Actichlor plus | NaDCC (Sodium Dichloroisocyanurate) | 1% |
| LifeClean | Chlorine dioxide | Undiluted |
| Etanol | Etanol | 70% |
| Chlorine | Sodium Hypochlorite solution | 2,5% |
| Virkon S | Dipotassium peroxodisulphate; Sulphamidic acid | 1% |
| Isopropanol | Isopropyl Alcohol | 70% |
| Oxivir Excel | Hydrogen peroxide | 0,5% |
| Sumabac D10 | Quaternary ammonium compound, Sodium carbonate | 1% |
| Suredis VT1 | n-(3-aminopropyl)-n-dodecylpropan-1,3-diamin | 1% |
| Enduro Chlor VE5 | Potassium hydroxide | 1,5% |
| Acipusfoam VF59 | Nitric Acid | 5% |

Tested according to ISO 11998 and withstands the following chemicals or disinfectants.



Mould and Bacterial Resistance

| Standard/Method | Class |
|--|------------------------------------|
| ISO 846 :2019 method C (for bacterium) | 0 (No growth under the microscope) |
| ASTM D3273-16 (for fungi) | 10 (0% growth on the surface) |



Clean Room

| Standard/Method | Class |
|-----------------|---|
| ISO 14644 | Particle cleanliness class ISO 4 |
| NF S 90-351 | Microbiological class M1/area 4 |
| NF S 90-351 | Particle elimination kinetics CP(0,5) 5 |



Accessibility

The tiles are demountable.



Installation

Installed according to installation diagrams, installation guides and drawing aid. Cut panels must be sealed with Connect Edge sealant. Penetrations must be sealed with a suitable sealant.



System weight

| | kg/m ² | Weight information is indicative and subject to variation. |
|--|-------------------|--|
| Hygiene Performance Ds | 2,5 | |
| Hygiene Performance Ds + Connect grid system | 3,4 | |



Mechanical properties

See table about Max live load and Min load bearing capacity and Functional demands, Mechanical properties at www.ecophon.com.



CE

Ecophon ceiling systems are CE marked according to the European harmonized standard EN13964:2014. CE marked construction products are covered by a Declaration of Performance (DOP) which enables customers and users to easily compare performance of products available on the European market.

INSTALLATION DIAGRAM (M616C4) FOR ECOPHON PERFORMANCE™ DS C4. SUSPENDED INSTALLATION

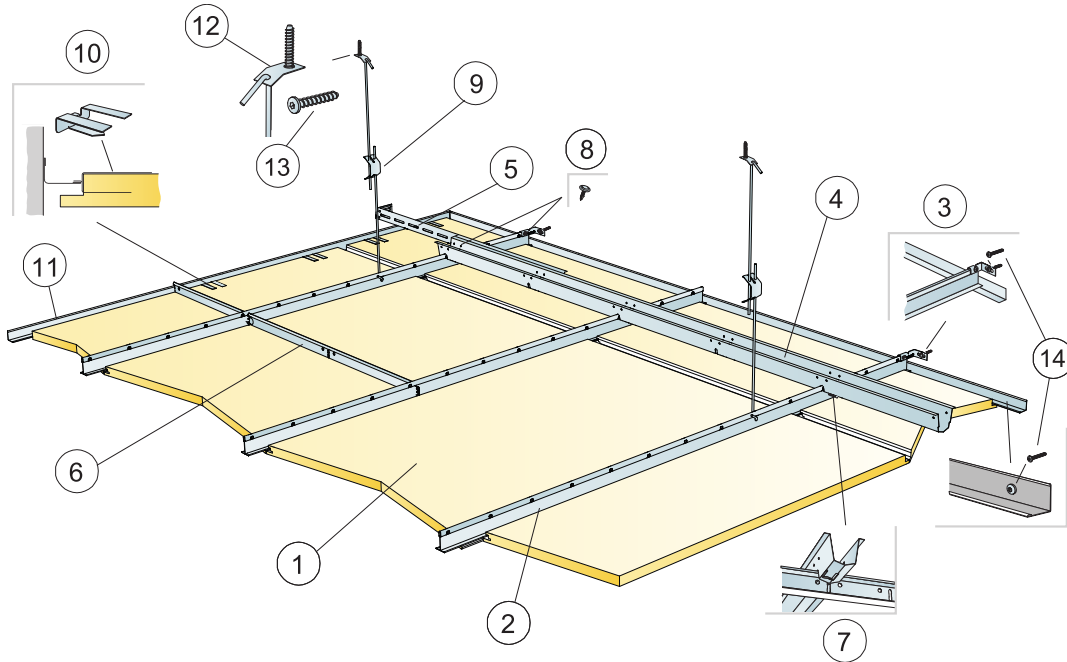

© Saint-Gobain Ecophon AB

QUANTITY SPECIFICATION (EXCL. WASTAGE)

| | Size, mm | |
|---|--|---------------------|
| | 600x600 | 1200x600 |
| 1 Hygiene Performance Ds | 2,8/m ² | 1,4/m ² |
| 2 Connect T24 Main Runner C4, installed at 600 mm centres | 1,7m/m ² | 1,7m/m ² |
| 3 Connect Wall Bracket C4 for T-profiles C4 | 1/suspended row of Main runner | |
| 4 Connect Space Bar C4, installed at 1500 mm centres (max. distance from wall 300 mm) for winch | 0,7m/m ² | 0,7m/m ² |
| 5 Connect Wall Bracket C4, l=700 mm, for Connect Space Bar | 1/row of Space bar | |
| 6 Connect T24 Cross Tee C4, l=600 mm | 2/row of Main runner | |
| 7 Connect Space Bar Winch C4, installed one per joint Connect Main Runner/Connect Space Bar | 1,4/m ² | 1,4/m ² |
| 8 C4 screw for wall brackets(included in products) | - | - |
| 9 Connect Adjustable Hanger C4, installed at 1200 mm centres (max. distance from wall 600 mm) | 0,7/m ² | 0,7/m ² |
| 10 Connect Support Clip Dg20 C4 | 1pc/300-400 mm on every cut perimeter tile with only 1 supporting edge | |
| 11 Connect Angle Trim 15/22 C4, fixed at 300 mm centres | as required | as required |
| 12 Connect Fixing Plate C4 | 0,7/m ² | 0,7/m ² |
| 13 Connect Anchor Screw C4 | 0,7/m ² | 0,7/m ² |
| 14 Connect Installation Screw C4 | 3,4/lm Channel trim C4 | |
| Δ Min. overall depth of system: 385 mm | - | - |
| δ Min. demounting depth: 30 mm | - | - |

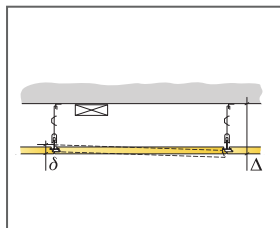

See Quantity Specification

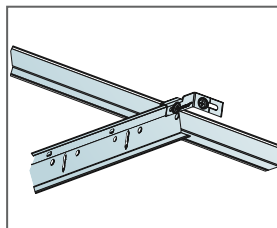

Secured Connect Main Runner C4 at wall with Connect Wall Bracket C4

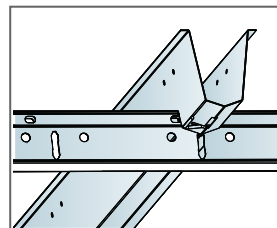

Connection between profiles with space bar winch

| Size, mm | Max live load [N] | Min load bearing capacity [N] |
|-------------|-------------------|-------------------------------|
| 600x600x20 | 40 | 160 |
| 1200x600x20 | 40 | 160 |

Live load/load bearing capacity



Ecophon Hygiene Performance™ Plus A

Ecophon Hygiene Performance™ Plus A has an exposed grid with fully sealed robust Hygiene Performance™ Plus A tiles and suitable for humid areas. The ceiling withstands advanced cleaning, such as steam and high/low pressure washing on a regular basis. The surface is resistant to common detergents and disinfectants.



Oilly, Landskrona, Sweden

SYSTEM RANGE

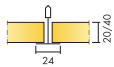

| Size, mm | 600x600 | 600x600 | 1200x600 | 1200x600 |
|-----------------|---------|---------|----------|----------|
| T24 | • | • | • | • |
| Thickness (THK) | 20 | 40 | 20 | 40 |
| Inst. Diag. | M466 | M466 | M466 | M466 |

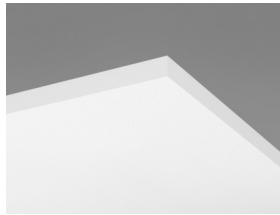

Hygiene Performance Plus A tile

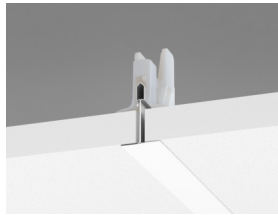

Hygiene Performance Plus A C3 section with Connect Hygiene Clip 20



Hygiene Performance Plus A system

Acoustic



Sound Absorption:

Test results according to EN ISO 354. Classification according to EN ISO 11654, and the single value ratings for Noise Reduction Coefficient, NRC and Sound Absorption Average, SAA according to ASTM C 423.

α_p , Practical sound absorption coefficient

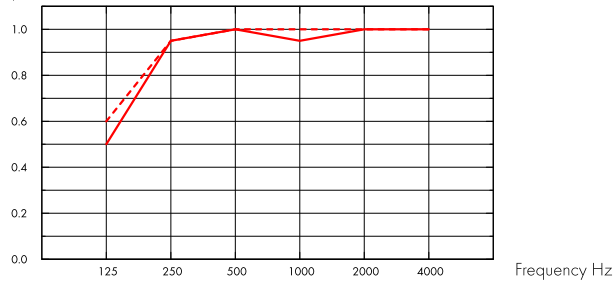

- Hygiene Performance Plus A 20 mm, 200 mm o.d.s.
 - - - Hygiene Performance Plus A 40 mm, 200 mm o.d.s.
- o.d.s = overall depth of system

| THK mm | o.d.s. mm | α_p , Practical sound absorption coefficient | | | | | | α_w | Sound absorption class |
|--------|-----------|---|--------|--------|---------|---------|---------|------------|------------------------|
| | | 125 Hz | 250 Hz | 500 Hz | 1000 Hz | 2000 Hz | 4000 Hz | | |
| 20 | 200 | 0.50 | 0.95 | 1.00 | 0.95 | 1.00 | 1.00 | 1.00 | A |
| 40 | 200 | 0.60 | 0.95 | 1.00 | 1.00 | 1.00 | 1.00 | 1.00 | A |

| THK mm | o.d.s. mm | NRC | SAA |
|--------|-----------|------|------|
| 20 | 200 | 1.00 | 0.97 |
| 40 | 200 | 1.00 | 0.99 |

Indoor Air Quality



| Certificate / Label | |
|------------------------------|----------|
| Eurofins Indoor Air Comfort® | IAC Gold |
| French VOC | A+ |



Cradle to Cradle Certified®



This product is Cradle to Cradle Certified® at Bronze level (version 4.0).



Material Health



This product has received a C2C Certified Material Health Certificate™ at the Silver level (standard version 4.0). The C2C Certified Material Health Certificate™ is a verification of the health and safety of a product's composition using the Material Health requirements of the Cradle-to-Cradle Certified Product Standard.



Carbon footprint

| | kg CO ₂ equiv/m ² | Life-cycle stages A1 to C4 from EPD, in conformity with ISO 14025 / EN 15804 |
|----------------------------------|---|--|
| Hygiene Performance Plus A, 20mm | 3,22 | |
| Hygiene Performance Plus A, 40mm | 5,19 | |



Circularity

| | |
|--|------------------|
| Minimum post-consumer recycled content | 44% |
| Recyclability | Fully recyclable |



Fire safety

| Country | Fire standard | Class | The glass wool core of the tiles is tested and classified as non-combustible according to EN ISO 1182. |
|---------|---------------|----------|--|
| Europe | EN 13501-1 | A2-s1,d0 | |



Humidity Resistance

Class D, relative humidity 97% and 50°C, according to EN 13964:2014



Visual appearance

White 500, nearest NCS colour sample S 0500-N, 84% light reflectance.



Cleanability

| Standard/Method | Frequency |
|-------------------------|-----------|
| Dusting | Daily |
| Wet wiping | Weekly |
| Steam cleaning | 4/year |
| Low pressure cleaning | 2/year |
| High pressure cleaning | 2/year |
| Hydrogen peroxide vapor | • |



Surface Endurance

Product tested according to ISO 11998, and withstand 200 cycles.



Chemical resistance/Disinfection

| Chemical | Active Substance | Concentration |
|------------------|--|---------------|
| Actichlor plus | NaDCC (Sodium Dichloroisocyanurate) | 1% |
| LifeClean | Chlorine dioxide | Undiluted |
| Etanol | Etanol | 70% |
| Chlorine | Sodium Hypochlorite solution | 2,5% |
| Virkon S | Dipotassium peroxodisulphate; Sulphamidic acid | 1% |
| Isopropanol | Isopropyl Alcohol | 70% |
| Oxivir Excel | Hydrogen peroxide | 0,5% |
| Sumabac D10 | Quaternary ammonium compound, Sodium carbonate | 1% |
| Suredis VT1 | n-(3-aminopropyl)-n-dodecylpropan-1,3-diamin | 1% |
| Enduro Chlor VE5 | Potassium hydroxide | 1,5% |
| Acipusfoam VF59 | Nitric Acid | 5% |

Tested according to ISO 11998 and withstands the following chemicals or disinfectants.



Mould and Bacterial Resistance

| Standard/Method | Class |
|--|------------------------------------|
| ISO 846 :2019 method C (for bacterium) | 0 (No growth under the microscope) |
| ASTM D3273-16 (for fungi) | 10 (0% growth on the surface) |



Clean Room

| | Standard/Method | Class |
|-------------|-------------------------------|-----------|
| ISO 14644 | Particle cleanliness class | ISO 4 |
| NF S 90-351 | Microbiological class | M1/area 4 |
| NF S 90-351 | Particle elimination kinetics | CP(0,5) 5 |



Installation

Installed according to installation diagrams, installation guides and drawing aid. Cut panels must be sealed with Connect Edge sealant. Penetrations must be sealed with a suitable sealant.



Accessibility

The tiles are demountable. Minimum demounting depth according to installation diagram. The tiles are secured using clips to allow for effective cleaning. The clips are easily removable from above the ceiling. An easy-to-open Connect Inspection hatch is available to simplify access to the ceiling void.



System weight

| | kg/m ² |
|--|-------------------|
| Hygiene Performance Plus A 20 mm | 1,5 |
| Hygiene Performance Plus A 20 mm + Connect grid system | 2,5 |
| Hygiene Performance Plus A 40 mm | 2,5 |
| Hygiene Performance Plus A 40 mm+ Connect grid system | 3,5 |

Weight information is indicative and subject to variation.



Mechanical properties

See table about Max live load and Min load bearing capacity and Functional demands, Mechanical properties at www.ecophon.com.



CE

Ecophon ceiling systems are CE marked according to the European harmonized standard EN13964:2014. CE marked construction products are covered by a Declaration of Performance (DOP) which enables customers and users to easily compare performance of products available on the European market.

INSTALLATION DIAGRAM (M466) FOR ECOPHON HYGIENE PERFORMANCE™ PLUS A C3

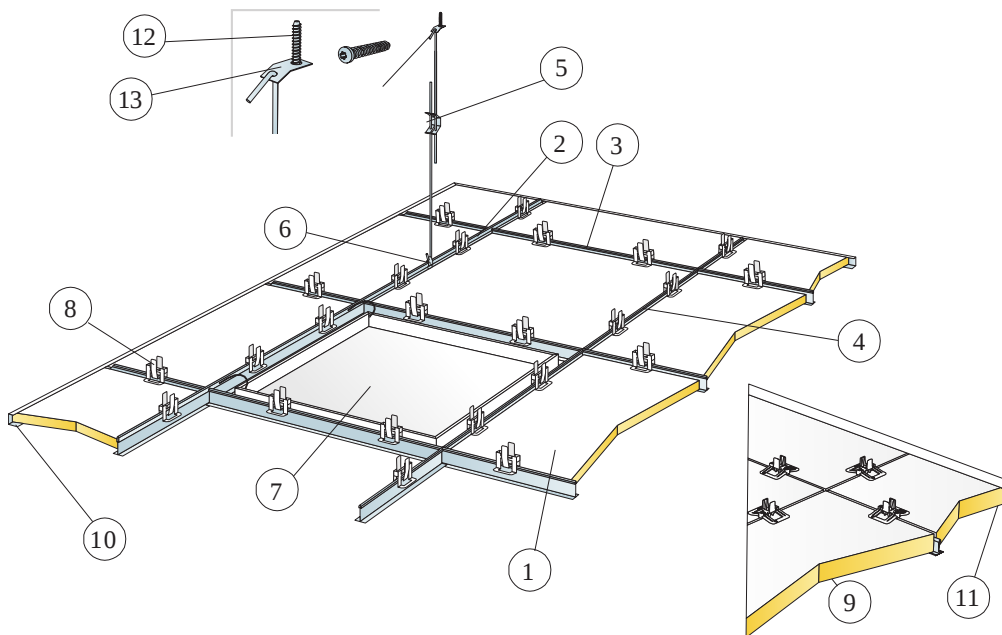

© Saint-Gobain Ecophon AB

QUANTITY SPECIFICATION (EXCL. WASTAGE)

| | Size, mm | |
|---|---------------------|---------------------|
| | 600x600 | 1200x600 |
| 1 Hygiene Performance Plus A | 2,8/m ² | 1,4/m ² |
| 2 Connect T24 Main Runner C3, installed at 1200 mm centres | 0,9m/m ² | 0,9m/m ² |
| 3 Connect T24 Cross Tee C3, L=1200 mm, installed at 600 mm centres | 1,7m/m ² | 1,7m/m ² |
| 4 Connect T24 Cross Tee C3, L=600 mm | 0,9m/m ² | - |
| 5 Connect Adjustable Hanger C3, c1200 (max distance from wall 600 mm) | 0,7/m ² | 0,7/m ² |
| 6 Connect Hanger Clip (not to be used in swimming hall environments) | 0,7/m ² | 0,7/m ² |
| 7 Connect Inspection Hatch C3 | as required | as required |
| 8 Connect Hygiene Clip 20 | 11/m ² | 7/m ² |
| 9 Connect Hygiene Clip 40 | 11/m ² | 7/m ² |
| 10 Connect Channel Trim C3, fixed c300 (for 20 mm thickness) | as required | as required |
| 11 Connect Channel Trim C3, fixed c300 (for 40 mm thickness) | as required | as required |
| 12 Connect Anchor Screw C4 | 0,7/m ² | 0,7/m ² |
| 13 Connect Fixing Plate C4 | 0,7/m ² | 0,7/m ² |
| Δ Min. overall depth of system: 150 mm | - | - |
| δ Min. demounting depth 20 mm: 150 mm | - | - |
| δ Min. demounting depth 40 mm: 170 mm | - | - |

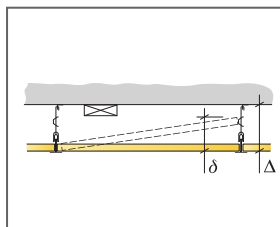

See Quantity Specification

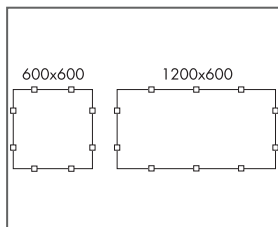

Arrangement of clips

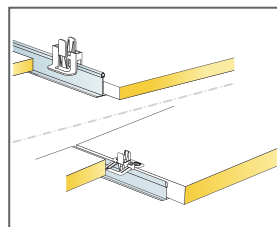

Clip for keeping tiles in place for 40 mm tiles

| Size, mm | Max live load [N] | Min load bearing capacity [N] |
|-------------|-------------------|-------------------------------|
| 600x600x20 | 50 | 160 |
| 600x600x40 | 50 | 160 |
| 1200x600x20 | 50 | 160 |
| 1200x600x40 | 50 | 160 |

Live load/load bearing capacity



Ecophon Hygiene Performance™ Baffle

Ecophon Hygiene Performance™ Baffle is an easy to clean, sound absorbing system with vertical baffles suitable for humid areas. The baffles withstand advanced cleaning, such as steam and high/low pressure washing on a regular basis.



SYSTEM RANGE



| | |
|-----------------|------------------------|
| Size, mm | 1200x600 |
| T24 | • |
| Thickness (THK) | 50 |
| Inst. Diagr. | M492C3, M493C3, M494C4 |

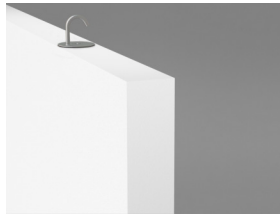

Solo Baffle/hook

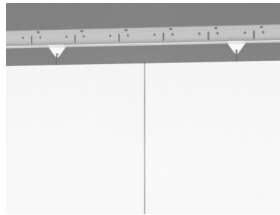

Hygiene Performance Baffle C4

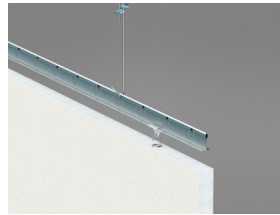

Hygiene Performance Baffle C4 installation

Acoustic



Sound Absorption:

Test results according to EN ISO 354:2003 NOTE: Results shown are not comparable with results according to older versions of this standard due to discrepancies in test method. Classification according to EN ISO 11654, and the single value ratings for Noise Reduction Coefficient, NRC and Sound Absorption Average, SAA according to ASTM C 423.

α_p , Practical sound absorption coefficient

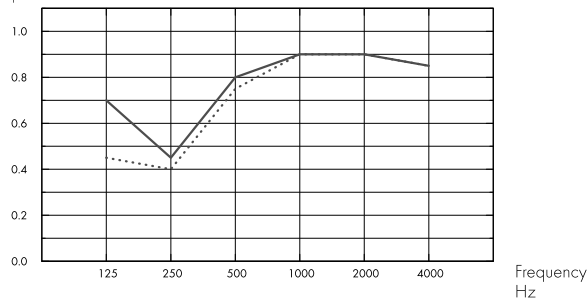

... Performance Baffle oriented in rows, c600 mm, with ~1,4 baffles/m² ceiling area, 600 mm o.d.s.

– Performance Baffle oriented in rectangles, with ~1,3 baffles/m² ceiling area, 600 mm o.d.s.

o.d.s = overall depth of system

| | THK mm | o.d.s. mm | α_p , Practical sound absorption coefficient | | | | | α_w | Sound absorption class | |
|---------------|--------|-----------|---|--------|--------|---------|---------|------------|------------------------|---------|
| | | | 125 Hz | 250 Hz | 500 Hz | 1000 Hz | 2000 Hz | | | 4000 Hz |
| in rows | 50 | 600 | 0.45 | 0.40 | 0.75 | 0.90 | 0.90 | 0.85 | 0.70 | C |
| in rectangles | 50 | 600 | 0.70 | 0.45 | 0.80 | 0.90 | 0.90 | 0.85 | 0.75 | C |

| | THK mm | o.d.s. mm | NRC | SAA |
|---------------|--------|-----------|------|------|
| in rows | 50 | 600 | 0.75 | 0.73 |
| in rectangles | 50 | 600 | 0.75 | 0.77 |

Indoor Air Quality



| Certificate / Label | |
|------------------------------|----------|
| Eurofins Indoor Air Comfort® | IAC Gold |
| French VOC | A+ |



Cradle to Cradle Certified®



This product is Cradle to Cradle Certified® at Bronze level (version 4.0).



Material Health



This product has received a C2C Certified Material Health Certificate™ at the Silver level (standard version 4.0). The C2C Certified Material Health Certificate™ is a verification of the health and safety of a product's composition using the Material Health requirements of the Cradle-to-Cradle Certified Product Standard.



Carbon footprint

| | | |
|----------------------------|---|--|
| | kg CO ₂ equiv/m ² | Life-cycle stages A1 to C4 from EPD, in conformity with ISO 14025 / EN 15804 |
| Hygiene Performance Baffle | 8,30 | |



Circularity

| | |
|--|------------------|
| Minimum post-consumer recycled content | 57% |
| Recyclability | Fully recyclable |



Fire safety

| | | | |
|---------|---------------|----------|--|
| Country | Fire standard | Class | The glass wool core of the tiles is tested and classified as non-combustible according to EN ISO 1182. |
| Europe | EN 13501-1 | A2-s1,d0 | |



Humidity Resistance

Class C, relative humidity 95% and 30°C, according to EN 13964:2014



Visual appearance

White 500, nearest NCS colour sample S 0500-N, 84% light reflectance.



Cleanability

| Standard/Method | Frequency |
|-------------------------|-----------|
| Dusting | Daily |
| Wet wiping | Weekly |
| Steam cleaning | 4/year |
| Low pressure cleaning | 2/year |
| High pressure cleaning | 2/year |
| Hydrogen peroxide vapor | • |



Surface Endurance

Product tested according to ISO 11998, and withstand 200 cycles.



Chemical resistance/Disinfection

| Chemical | Active Substance | Concentration |
|------------------|--|---------------|
| Actichlor plus | NaDCC (Sodium Dichloroisocyanurate) | 1% |
| LifeClean | Chlorine dioxide | Undiluted |
| Etanol | Etanol | 70% |
| Chlorine | Sodium Hypochlorite solution | 2,5% |
| Virkon S | Dipotassium peroxodisulphate; Sulphamidic acid | 1% |
| Isopropanol | Isopropyl Alcohol | 70% |
| Oxivir Excel | Hydrogen peroxide | 0,5% |
| Sumabac D10 | Quaternary ammonium compound, Sodium carbonate | 1% |
| Suredis VT1 | n-(3-aminopropyl)-n-dodecylpropan-1,3-diamin | 1% |
| Enduro Chlor VE5 | Potassium hydroxide | 1,5% |
| Acipusfoam VF59 | Nitric Acid | 5% |

Tested according to ISO 11998 and withstands the following chemicals or disinfectants.



Mould and Bacterial Resistance

| Standard/Method | Class |
|--|------------------------------------|
| ISO 846 :2019 method C (for bacterium) | 0 (No growth under the microscope) |
| ASTM D3273-16 (for fungi) | 10 (0% growth on the surface) |



Clean Room

| Standard/Method | Class |
|-----------------|---|
| ISO 14644 | Particle cleanliness class ISO 4 |
| NF S 90-351 | Microbiological class M1/area 4 |
| NF S 90-351 | Particle elimination kinetics CP(0,5) 5 |



Accessibility

The tiles are demountable.



Installation

Installed according to installation diagrams, installation guides and drawing aid. Cut panels must be sealed with Connect Edge sealant.



System weight

| | kg/m ² |
|----------------------------|-------------------|
| Hygiene Performance Baffle | 4,8 |

Weight information is indicative and subject to variation.



Mechanical properties

Please observe that vibrations, airflow and other types of mechanical impact can affect the mechanical properties of the fixings.



CE

Ecophon ceiling systems are CE marked according to the European harmonized standard EN13964:2014. CE marked construction products are covered by a Declaration of Performance (DOP) which enables customers and users to easily compare performance of products available on the European market.

INSTALLATION DIAGRAM (M492C3) FOR ECOPHON HYGIENE PERFORMANCE™ Baffle C3 (IN ROWS)

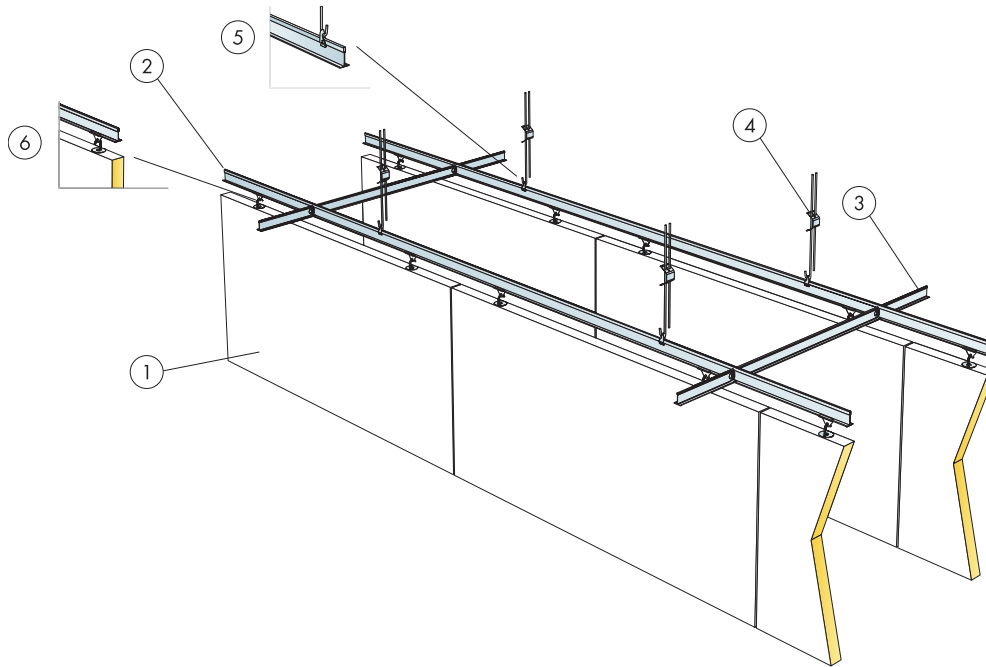

© Saint-Gobain Ecophon AB

QUANTITY SPECIFICATION (EXCL. WASTAGE)

| | | Size, mm |
|---|--|---------------------|
| | | 1200x600 |
| 1 | Hygiene Performance Baffle | 1,4/m ² |
| 2 | Connect T24 Main Runner C3, installed at 600 mm centres | 1,7m/m ² |
| 3 | Connect T24 Cross Tee C3, L=600 mm, installed at 1800 mm centres | 0,6m/m ² |
| 4 | Connect Adjustable Hanger C3 c1200 | 1,4/m ² |
| 5 | Connect Hanger Clip | 1,4/m ² |
| 6 | Connect Baffle Clip C3 | 2,8/m ² |

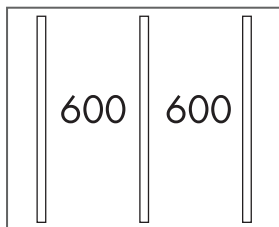

Installation in rows

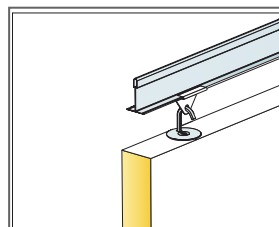

Detail of suspension

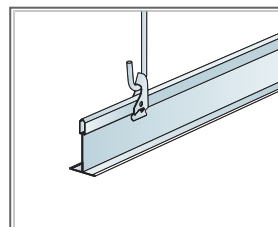

Suspension with Connect Adjustable Hanger and Connect Hanger Clip

| Size, mm | Max live load [N] | Min load bearing capacity [N] |
|-------------|-------------------|-------------------------------|
| 1200x600x50 | 0 | 160 |

Live load/load bearing capacity

INSTALLATION DIAGRAM (M493C3) FOR ECOPHON HYGIENE PERFORMANCE™ Baffle C3 (IN RECTANGLES)

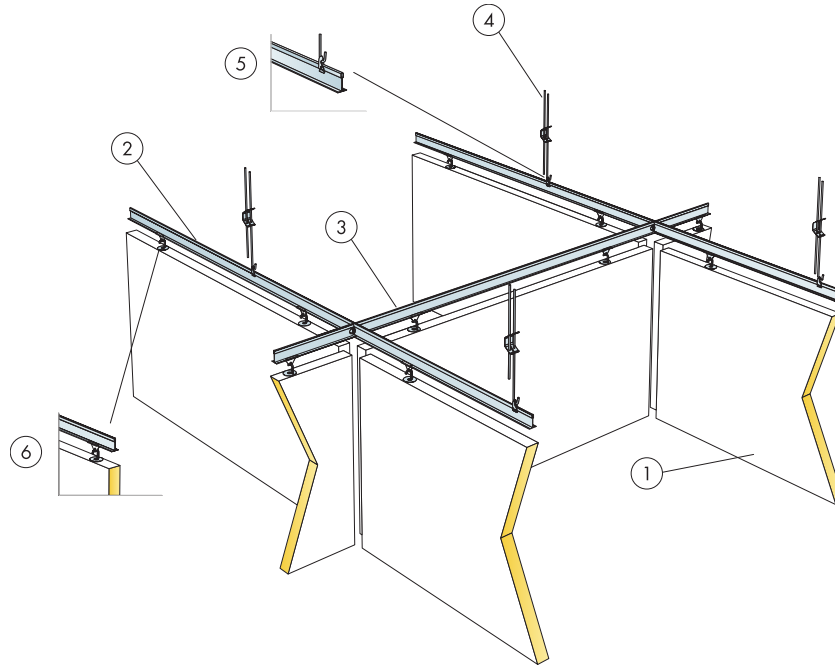

© Saint-Gobain Ecophon AB

QUANTITY SPECIFICATION (EXCL. WASTAGE)

| | | Size, mm |
|---|---|---------------------|
| | | 1200x600 |
| 1 | Hygiene Performance Baffle | 1,3/m ² |
| 2 | Connect T24 Main Runner C3, installed at 1250 mm centres | 0,8m/m ² |
| 3 | Connect T24 Cross Tee C3, L=1250 mm, installed at 1300 mm centres | 0,8m/m ² |
| 4 | Connect Adjustable Hanger C3 | 0,7/m ² |
| 5 | Connect Hanger Clip | 0,7/m ² |
| 6 | Connect Baffle Clip C3 | 2,5/m ² |

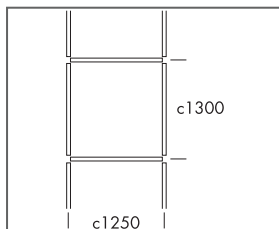

Installation in rectangles

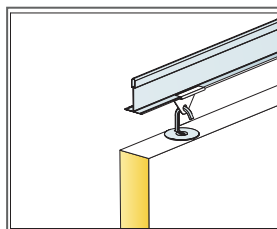

Detail of suspension

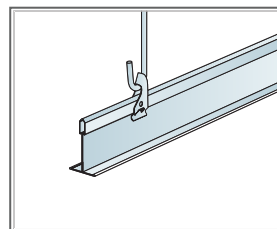

Suspension with Connect Adjustable Hanger and Connect Hanger Clip

| Size, mm | Max live load [N] | Min load bearing capacity [N] |
|-------------|-------------------|-------------------------------|
| 1200x600x50 | 0 | 160 |

Live load/load bearing capacity

INSTALLATION DIAGRAM (M494C4) FOR ECOPHON HYGIENE PERFORMANCE™ Baffle C4 (IN ROWS)

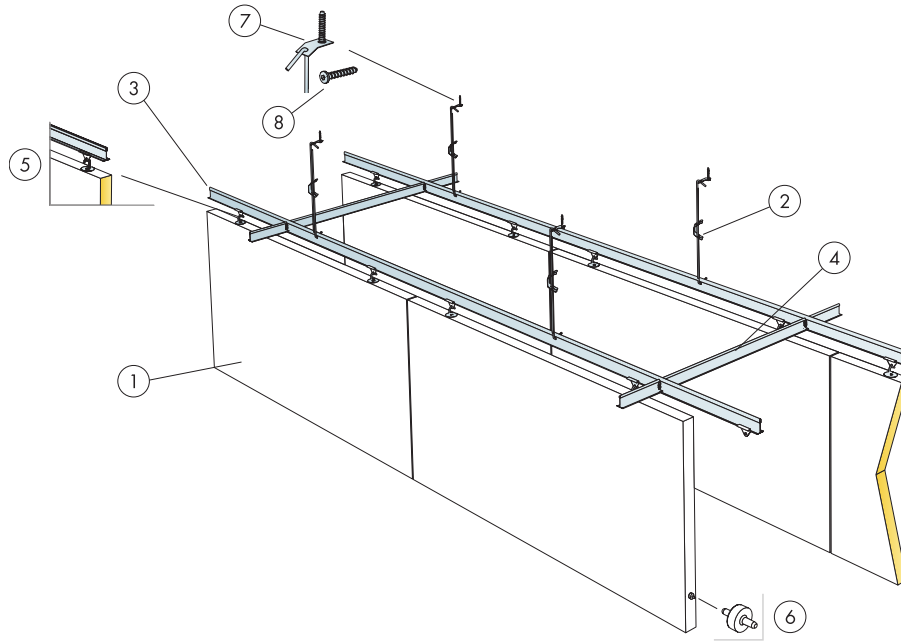

© Saint-Gobain Ecophon AB

QUANTITY SPECIFICATION (EXCL. WASTAGE)

| | | Size, mm |
|---|--|---------------------|
| | | 1200x600 |
| 1 | Hygiene Performance Baffle | 1,4/m ² |
| 2 | Connect Adjustable Hanger C4 c1200 | 1,4/m ² |
| 3 | Connect T24 Main Runner C4, installed at 600 mm centres | 1,7m/m ² |
| 4 | Connect T24 Cross Tee C4, L=600 mm, installed at 1800 mm centres | 0,6m/m ² |
| 5 | Connect Baffle Clip C4 | 2,8/m ² |
| 6 | Connect Guiding Pin, installed at 1200/1800 mm centres | 2,8/m ² |
| 7 | Connect Fixing Plate C4 | 1,4/m ² |
| 8 | Connect Anchor Screw C4 | 1,4/m ² |

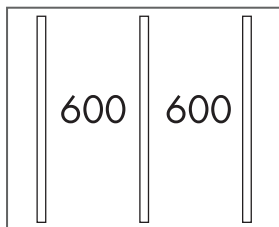

Installation in rows

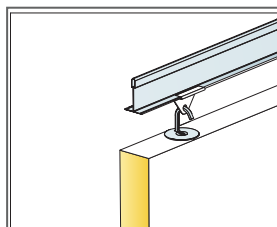

Detail of suspension

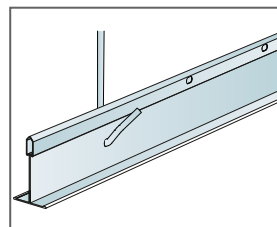

Suspension with Connect Adjustable Hanger C4

| Size, mm | Max live load [N] | Min load bearing capacity [N] |
|-------------|-------------------|-------------------------------|
| 1200x600x50 | 0 | 160 |

Live load/load bearing capacity



Ecophon Hygiene Performance™ Wall

Ecophon Hygiene Performance™ Wall is an easy to clean, sound absorbing wall panel system suitable for humid areas. The panels withstand advanced cleaning, such as steam and high/low pressure washing on a regular basis.



TAYS kitchen, Tampere, Finland

SYSTEM RANGE

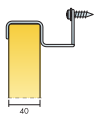

| | |
|-----------------|----------|
| Size, mm | 1200x600 |
| Special Fixing | • |
| Thickness (THK) | 40 |
| Inst. Diagr. | M467 |

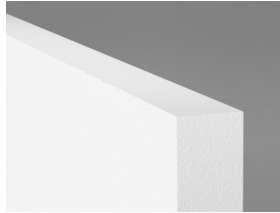

Hygiene Performance Wall

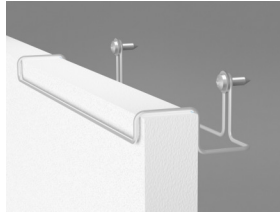

Connect Wall fixing C3



Hygiene Performance Wall C3 system

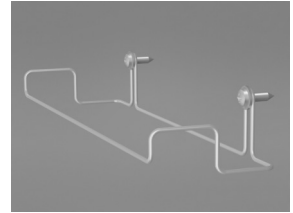

Connect Wall Fixing C3

Acoustic



Sound Absorption:

Test results according to EN ISO 354. Classification according to EN ISO 11654.

α_p , Practical sound absorption coefficient

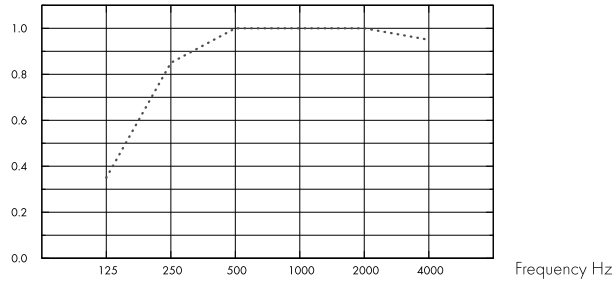

... Hygiene Performance Wall, 80 mm o.d.s.

o.d.s = overall depth of system

| THK mm | o.d.s. mm | α_p , Practical sound absorption coefficient | | | | | | α_w | Sound absorption class |
|-----------|-----------|---|--------|--------|---------|---------|---------|------------|------------------------|
| | | 125 Hz | 250 Hz | 500 Hz | 1000 Hz | 2000 Hz | 4000 Hz | | |
| 40 | 80 | 0.35 | 0.85 | 1.00 | 1.00 | 1.00 | 0.95 | 1.00 | A |

| THK mm | o.d.s. mm | NRC | SAA |
|-----------|-----------|------|------|
| 40 | 80 | 0.95 | 0.95 |

Indoor Air Quality



| Certificate / Label | |
|------------------------------|----------|
| Eurofins Indoor Air Comfort® | IAC Gold |
| French VOC | A+ |



Cradle to Cradle Certified®



This product is Cradle to Cradle Certified® at Bronze level (version 4.0).



Material Health



This product has received a C2C Certified Material Health Certificate™ at the Silver level (standard version 4.0). The C2C Certified Material Health Certificate™ is a verification of the health and safety of a product's composition using the Material Health requirements of the Cradle-to-Cradle Certified Product Standard.



Carbon footprint

| | kg CO ₂ equiv/m ² | Life-cycle stages A1 to C4 from EPD, in conformity with ISO 14025 / EN 15804 |
|--------------------------|---|--|
| Hygiene Performance Wall | 7,13 | |



Circularity

| | |
|--|------------------|
| Minimum post-consumer recycled content | 54% |
| Recyclability | Fully recyclable |



Fire safety

| Country | Fire standard | Class |
|---------|---------------|----------|
| Europe | EN 13501-1 | A2-s1,d0 |

The glass wool core of the tiles is tested and classified as non-combustible according to EN ISO 1182.



Humidity Resistance

Class C, relative humidity 95% and 30°C, according to EN 13964:2014



Visual appearance

White 500, nearest NCS colour sample S 0500-N, 84% light reflectance.



Cleanability

| Standard/Method | Frequency |
|-------------------------|-----------|
| Dusting | Daily |
| Wet wiping | Weekly |
| Steam cleaning | 4/year |
| Low pressure cleaning | 2/year |
| High pressure cleaning | 2/year |
| Hydrogen peroxide vapor | • |



Surface Endurance

Product tested according to ISO 11998, and withstand 200 cycles.



Chemical resistance/Disinfection

| Chemical | Active Substance | Concentration |
|------------------|--|---------------|
| Actichlor plus | NaDCC (Sodium Dichloroisocyanurate) | 1% |
| LifeClean | Chlorine dioxide | Undiluted |
| Etanol | Etanol | 70% |
| Chlorine | Sodium Hypochlorite solution | 2,5% |
| Virkon S | Dipotassium peroxodisulphate; Sulphamidic acid | 1% |
| Isopropanol | Isopropyl Alcohol | 70% |
| Oxivir Excel | Hydrogen peroxide | 0,5% |
| Sumabac D10 | Quaternary ammonium compound, Sodium carbonate | 1% |
| Suredis VT1 | n-(3-aminopropyl)-n-dodecylpropan-1,3-diamin | 1% |
| Enduro Chlor VE5 | Potassium hydroxide | 1,5% |
| Acipusfoam VF59 | Nitric Acid | 5% |

Tested according to ISO 11998 and withstands the following chemicals or disinfectants.



Mould and Bacterial Resistance

| Standard/Method | Class |
|--|------------------------------------|
| ISO 846 :2019 method C (for bacterium) | 0 (No growth under the microscope) |
| ASTM D3273-16 (for fungi) | 10 (0% growth on the surface) |



Clean Room

| Standard/Method | Class |
|-----------------|---|
| ISO 14644 | Particle cleanliness class ISO 4 |
| NF S 90-351 | Microbiological class M1/area 4 |
| NF S 90-351 | Particle elimination kinetics CP(0,5) 5 |



Accessibility

The tiles are demountable.



Installation

Installed according to installation diagrams, installation guides and drawing aid. For information regarding minimum overall depth of system see quantity specification.



System weight

| | kg/m ² |
|--------------------------|-------------------|
| Hygiene Performance Wall | 4,0 |

Weight information is indicative and subject to variation.



Mechanical properties

See table about Max live load and Min load bearing capacity and Functional demands, Mechanical properties at www.ecophon.com.



CE

Ecophon ceiling systems are CE marked according to the European harmonized standard EN13964:2014. CE marked construction products are covered by a Declaration of Performance (DOP) which enables customers and users to easily compare performance of products available on the European market.

INSTALLATION DIAGRAM (M467) FOR ECOPHON HYGIENE PERFORMANCE™ WALL C3

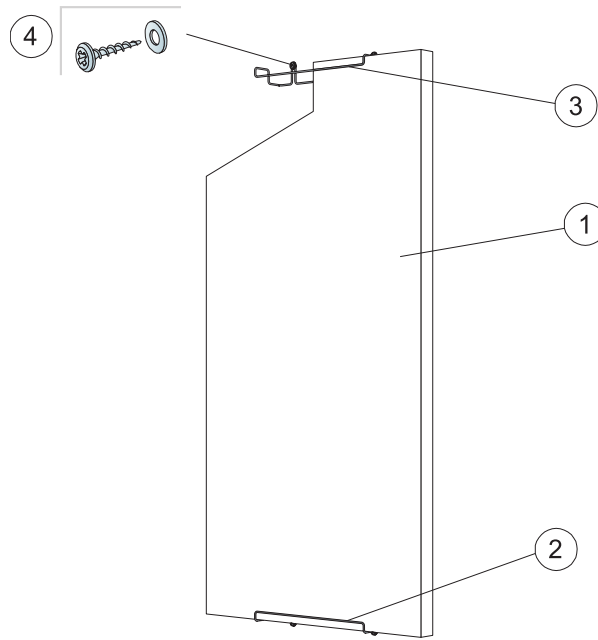

© Saint-Gobain Ecophon AB

QUANTITY SPECIFICATION (EXCL. WASTAGE)

| | | Size, mm |
|---------------------------------------|---|--------------------|
| | | 1200x600 |
| 1 | Hygiene Performance Wall | 1,4/m ² |
| 2 | Connect Wall Fixing C3, vertical installation | 2/panel |
| 3 | Connect Wall Fixing C3, horizontal installation | 4/panel |
| 4 | Wall screw, A2 material (not supplied by Ecophon) | 2/wall fixing |
| Δ Min. overall depth of system: 90 mm | | - |

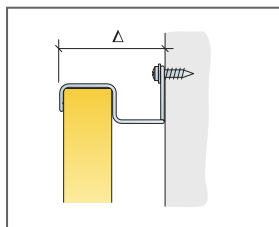

See Quantity Specification

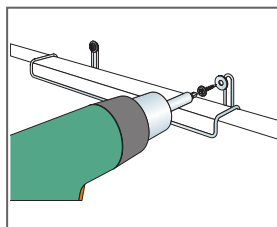

Installation with wall screw in stainless steel (A2) material

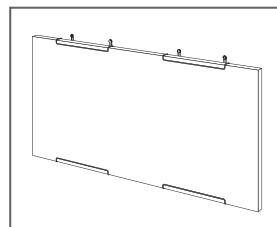

Horizontal installation of Performance Wall C3

| Size, mm | Max live load [N] | Min load bearing capacity [N] |
|-------------|-------------------|-------------------------------|
| 1200x600x40 | 0 | - |

Live load/load bearing capacity



Ecophon Hygiene Performance™ Care Wall

Ecophon Hygiene Performance™ Care Wall is an easy to clean, sound absorbing wall panel system for healthcare applications or other areas with elevated hygiene standards. The surface is resistant to common detergents and disinfectants. The panels withstand steam cleaning.



Healthcare launch 2019, Sweden

SYSTEM RANGE



| | |
|------------------|-----------|
| Size, mm | 2700x1200 |
| Thinline Profile | • |
| Thickness (THK) | 40 |
| Inst. Diag. | M610 |

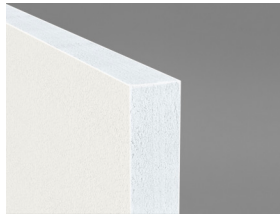

Hygiene Performance Care Wall



Hygiene Performance Care Wall system with Connect Thinline profiles

Acoustic



Sound Absorption:

Test results according to EN ISO 354. Classification according to EN ISO 11654.

α_p , Practical sound absorption coefficient

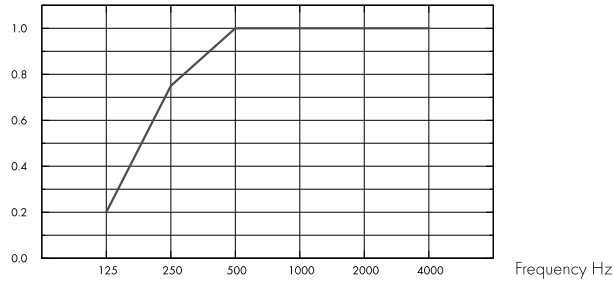

– Hygiene Performance Care Wall 40 mm, 50 mm o.d.s.

o.d.s = overall depth of system

| THK mm | o.d.s. mm | α_p , Practical sound absorption coefficient | | | | | | α_w | Sound absorption class |
|--------|-----------|---|--------|--------|---------|---------|---------|------------|------------------------|
| | | 125 Hz | 250 Hz | 500 Hz | 1000 Hz | 2000 Hz | 4000 Hz | | |
| 40 | 50 | 0.20 | 0.75 | 1.00 | 1.00 | 1.00 | 1.00 | 1.00 | A |

| THK mm | o.d.s. mm | NRC | SAA |
|--------|-----------|------|------|
| 40 | 50 | 0.95 | 0.96 |

Indoor Air Quality



| Certificate / Label | |
|------------------------------|----------|
| Eurofins Indoor Air Comfort® | IAC Gold |
| French VOC | A+ |



Cradle to Cradle Certified®



This product is Cradle to Cradle Certified® at Bronze level (version 4.0).



Material Health



This product has received a C2C Certified Material Health Certificate™ at the Silver level (standard version 4.0). The C2C Certified Material Health Certificate™ is a verification of the health and safety of a product's composition using the Material Health requirements of the Cradle-to-Cradle Certified Product Standard.



Circularity

| | |
|--|------------------|
| Minimum post-consumer recycled content | 58% |
| Recyclability | Fully recyclable |



Fire safety

| Country | Fire standard | Class |
|---------|---------------|----------|
| Europe | EN 13501-1 | A2-s1,d0 |

The glass wool core of the tiles is tested and classified as non-combustible according to EN ISO 1182.



Humidity Resistance

Class C, relative humidity 95% and 30°C, according to EN 13964:2014



Visual appearance

White 500, nearest NCS colour sample S 0500-N, 84% light reflectance.



Cleanability

| Standard/Method | Frequency |
|-------------------------|-----------|
| Dusting | Daily |
| Wet wiping | Weekly |
| Steam cleaning | 4/year |
| Hydrogen peroxide vapor | • |



Surface Endurance

Product tested according to ISO 11998, and withstand 200 cycles.



Chemical resistance/Disinfection

| Chemical | Active Substance | Concentration |
|------------------|--|---------------|
| Actichlor plus | NaDCC (Sodium Dichloroisocyanurate) | 1% |
| LifeClean | Chlorine dioxide | Undiluted |
| Etanol | Etanol | 70% |
| Chlorine | Sodium Hypochlorite solution | 2,5% |
| Virkon S | Dipotassium peroxodisulphate; Sulphamidic acid | 1% |
| Isopropanol | Isopropyl Alcohol | 70% |
| Oxivir Excel | Hydrogen peroxide | 0,5% |
| Sumabac D10 | Quaternary ammonium compound, Sodium carbonate | 1% |
| Suredis VT1 | n-(3-aminopropyl)-n-dodecylpropan-1,3-diamin | 1% |
| Enduro Chlor VE5 | Potassium hydroxide | 1,5% |
| Acipusfoam VF59 | Nitric Acid | 5% |

Tested according to ISO 11998 and withstands the following chemicals or disinfectants.



Mould and Bacterial Resistance

| Standard/Method | Class |
|--|------------------------------------|
| ISO 846 :2019 method C (for bacterium) | 0 (No growth under the microscope) |
| ASTM D3273-16 (for fungi) | 10 (0% growth on the surface) |



Clean Room

| Standard/Method | Class |
|-----------------|---|
| ISO 14644 | Particle cleanliness class ISO 4 |
| NF S 90-351 | Microbiological class M1/area 4 |
| NF S 90-351 | Particle elimination kinetics CP(0,5) 5 |



Accessibility

The tiles are not demountable except in selected installation diagrams. See quantity specification for more information.



System weight

| | kg/m ² | Weight information is indicative and subject to variation. |
|-------------------------------|-------------------|--|
| Hygiene Performance Care Wall | 3,7 | |



Installation

Installed according to installation diagrams, installation guides and drawing aid. For information regarding minimum overall depth of system see quantity specification.



Mechanical properties

See table about Max live load and Min load bearing capacity and Functional demands, Mechanical properties at www.ecophon.com.



CE

Ecophon ceiling systems are CE marked according to the European harmonized standard EN13964:2014. CE marked construction products are covered by a Declaration of Performance (DOP) which enables customers and users to easily compare performance of products available on the European market.

INSTALLATION DIAGRAM (M610) FOR ECOPHON HYGIENE PERFORMANCE™ CARE WALL INSTALLATION WITH CONNECT THINLINE PROFILE.

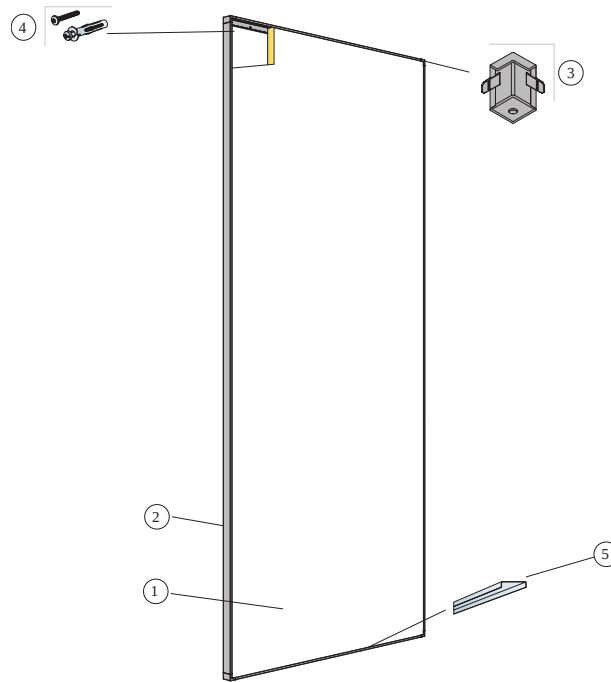

© Saint Gobain Ecophon AB

QUANTITY SPECIFICATION (EXCL. WASTAGE)

| | Size, mm |
|--|---------------------|
| | 2700x1200 |
| 1 Hygiene Performance Care Wall | 0,31/m ² |
| 2 Connect Thinline Profile, L=2658 mm | as required |
| 3 Connect Thinline Corner | as required |
| 4 Installation screw, installed at 200 mm centres (select fastener according to wall material) | as required |
| 5 Connect Thinline Space Bar | as required |
| Δ Overall depth of system: 45 mm | - |

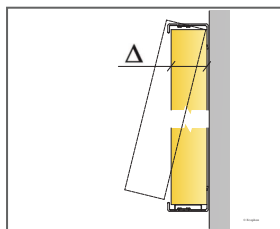

See Quantity specification

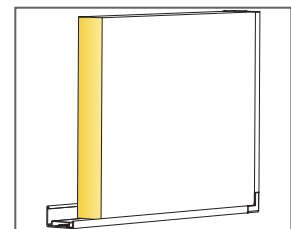

Detail of panel with Thinline system

Ecophon Hygiene Advance™

A

Ecophon Hygiene Advance™ A is a sound-absorbing ceiling with an exposed grid that sustains daily advanced cleaning and disinfection with strong chemicals. Suitable for the most demanding conditions. Available with corrosion class C3 grids for humid areas and C4 grids for constantly wet areas.



SYSTEM RANGE

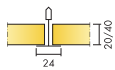

| Size, mm | 600x600 | 600x600 | 1200x600 | 1200x600 |
|-----------------|----------------|----------------|----------------|----------------|
| T24 | • | • | • | • |
| Thickness (THK) | 20 | 40 | 20 | 40 |
| Inst. Diagr. | M246C4, M252C3 | M246C4, M252C3 | M246C4, M252C3 | M246C4, M252C3 |

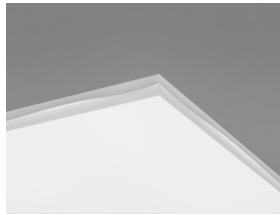

Hygiene Advance A tile

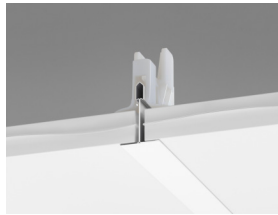

Hygiene Advance A C4 section with Connect Hygiene clip 20



Hygiene Advance A C4 system

Acoustic



Hygiene Advance Technical tile has no performance determined (n.p.d.) for sound absorption.

Sound Absorption:

Test results according to EN ISO 354. Classification according to EN ISO 11654, and the single value ratings for Noise Reduction Coefficient, NRC and Sound Absorption Average, SAA according to ASTM C 423.

α_p , Practical sound absorption coefficient

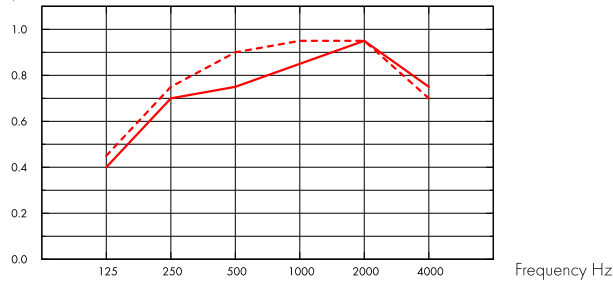

— Hygiene Advance A 20 mm, 200 mm o.d.s.

- - - Hygiene Advance A 40 mm, 200 mm o.d.s.

o.d.s = overall depth of system

| THK mm | o.d.s. mm | α_p , Practical sound absorption coefficient | | | | | | α_w | Sound absorption class |
|--------|-----------|---|--------|--------|---------|---------|---------|------------|------------------------|
| | | 125 Hz | 250 Hz | 500 Hz | 1000 Hz | 2000 Hz | 4000 Hz | | |
| 20 | 200 | 0.40 | 0.70 | 0.75 | 0.85 | 0.95 | 0.75 | 0.85 | B |
| 40 | 200 | 0.45 | 0.75 | 0.90 | 0.95 | 0.95 | 0.70 | 0.90 | A |

| THK mm | o.d.s. mm | NRC | SAA |
|--------|-----------|------|------|
| 20 | 200 | 0.80 | 0.76 |
| 20 | 400 | 0.80 | 0.79 |
| 40 | 200 | 0.75 | 0.76 |
| 40 | 400 | 0.75 | 0.76 |

Indoor Air Quality



| Certificate / Label | |
|------------------------------|----------|
| Eurofins Indoor Air Comfort® | IAC Gold |
| French VOC | A+ |
| Finnish M1 | • |



Carbon footprint



| | kg CO ₂ equiv/m ² |
|----------------|---|
| Advance A 20mm | 9,32 |
| Advance A 40mm | 16,23 |

Life-cycle stages A1 to C4 from EPD, in conformity with ISO 14025 / EN 15804



Circularity

| | |
|--|------------------|
| Minimum post-consumer recycled content | 59% |
| Recyclability | Fully recyclable |



Fire safety

| Country | Fire standard | Class |
|---------|---------------|----------|
| Europe | EN 13501-1 | A2-s1,d0 |

The glass wool core of the tiles is tested and classified as non-combustible according to EN ISO 1182.



Humidity Resistance

Class D, relative humidity 97% and 50°C, according to EN 13964:2014



Visual appearance

White 141, nearest NCS colour sample S 1000-N, 73% light reflectance. Please note: There is a small difference in gloss and appearance between the Hygiene Advance tile and the Hygiene Advance technical tile.



Cleanability

| Standard/Method | Frequency |
|--------------------------|-----------|
| Dusting | Daily |
| Wet wiping | Daily |
| Steam cleaning | Daily |
| Low pressure cleaning | Daily |
| High pressure cleaning | Daily |
| Hydrogen peroxide vapor | • |
| UV-C, BIFMA HCF 8.1-2019 | • |



Chemical resistance/Disinfection

| Chemical | Concentration |
|---------------------|---------------|
| Formalin | 37% |
| Ammoniac | 25% |
| Hydrogen peroxide | 30% |
| Sulfuric acid | 5% |
| Phosphoric acid | 30% |
| Peracetic acid | 15% |
| Hydrochloric acid | 5% |
| Isopropanol | 100% |
| Sodium hydroxide | 5% |
| Sodium hypochlorite | 5% |

Tested according to ISO 2812-1 and classified according to ISO 4628-1 with excellent result for the following chemicals.



Mould and Bacterial Resistance

| Standard/Method | Class |
|-----------------|-------|
|-----------------|-------|



Clean Room

| | Standard/Method | Class |
|-------------|-------------------------------|-----------|
| ISO 14644 | Particle cleanliness class | ISO 3 |
| NF S 90-351 | Microbiological class | M1/area 4 |
| NF S 90-351 | Particle elimination kinetics | CP(0,5) 1 |



Air permeability

| Advance 20 mm | Positive pressure m ³ /(h x m ²) | Negative pressure m ³ /(h x m ²) | Positive pressure L/s/m ² | Negative pressure L/s/m ² | Advance A 40 mm | Positive pressure m ³ /(h x m ²) | Negative pressure m ³ /(h x m ²) | Positive pressure L/s/m ² | Negative pressure L/s/m ² | Air leak rate measured at positive respective negative room pressure up to 50 Pa (Q50) EN ISO 9972 :2015 |
|------------------|--|--|--|--|--------------------|--|--|--|--|---|
| 10 (Pa) | 13,1 | 12,5 | 3,6 | 3,5 | 10 (Pa) | 4,2 | 4,4 | 1,2 | 1,2 | |
| 20 (Pa) | 20,9 | 17,9 | 5,8 | 5,0 | 20 (Pa) | 6,1 | 6,3 | 1,7 | 1,7 | |
| 30 (Pa) | 27,5 | 22,0 | 7,6 | 6,1 | 30 (Pa) | 7,7 | 7,7 | 2,1 | 2,1 | |
| 40 (Pa) | 33,4 | 25,5 | 9,3 | 7,1 | 40 (Pa) | 9,1 | 8,9 | 2,5 | 2,5 | |
| 50 (Pa) /Q50 | 38,8 | 28,6 | 10,8 | 8,0 | 50 (Pa) /Q50 | 10,3 | 10,0 | 2,9 | 2,8 | |



Accessibility

The tiles are demountable. Minimum demounting depth according to installation diagram. The tiles are secured using Connect Hygiene Clip to allow for effective cleaning. The clips are easily removable from above the ceiling. Connect Democlips 20 C4 are available to simplify access to the ceiling void.



Installation

Installed according to installation diagrams, installation guides and drawing aid. Cut tiles must be sealed with Connect Hygiene Advance Tape. Penetrations must be sealed with a suitable sealant.



System weight

The weight of the system (including suspension grid) should be approximately 3 kg/m² for 20 mm thickness and 4,5 kg/m² for 40 mm thickness.



Mechanical properties

See table about Max live load and Min load bearing capacity and Functional demands, Mechanical properties at www.ecophon.com.



CE

Ecophon ceiling systems are CE marked according to the European harmonized standard EN13964:2014. CE marked construction products are covered by a Declaration of Performance (DOP) which enables customers and users to easily compare performance of products available on the European market.

| | |
|--|------------------------------------|
| ISO 846 :2019 method C (for bacterium) | 0 (No growth under the microscope) |
| ASTM D3273-16 (for fungi) | 10 (0% growth on the surface) |

INSTALLATION DIAGRAM (M246) FOR ECOPHON HYGIENE ADVANCE™ A C4

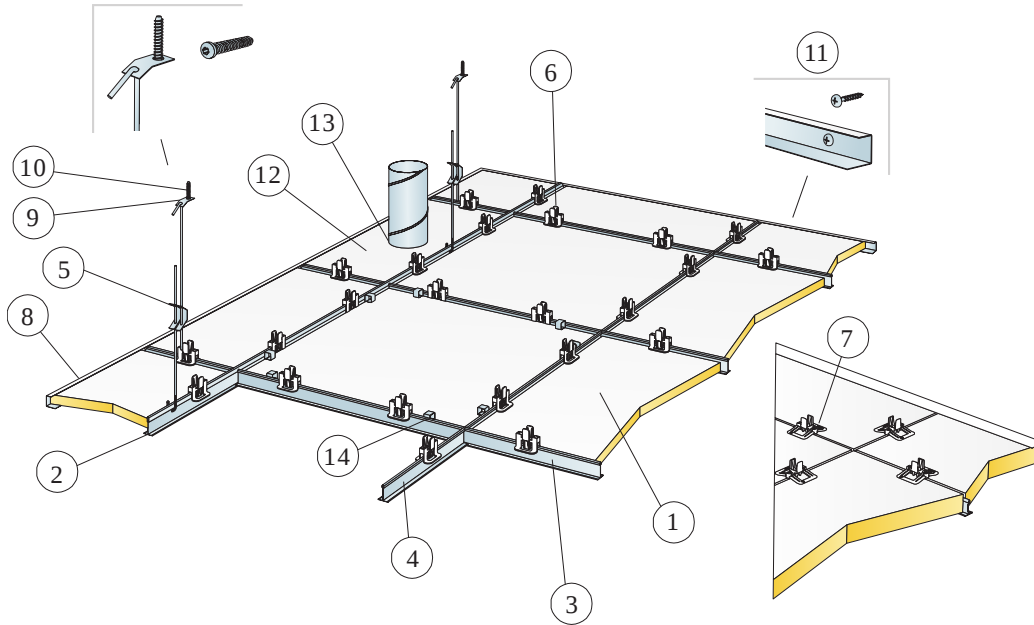

© Saint-Gobain Ecophon AB

QUANTITY SPECIFICATION (EXCL. WASTAGE)

| | Size, mm | |
|--|-----------------------|---------------------|
| | 600x600 | 1200x600 |
| 1 Hygiene Advance A | 2,8/m ² | 1,4/m ² |
| 2 Connect T24 Main Runner C4, c1200 | 0,9m/m ² | 0,9m/m ² |
| 3 Connect T24 Cross Tee C4, l=1200, c600 | 1,7m/m ² | 1,7m/m ² |
| 4 Connect T24 Cross Tee C4, l=600 | 0,9m/m ² | - |
| 5 Connect Adjustable Hanger C4, c1200, (max 600 mm distance from wall) | 0,7/m ² | 0,7/m ² |
| 6 Connect Hygiene Clip 20 | 11/m ² | 7/m ² |
| 7 Connect Hygiene Clip 40 C4 | 11/m ² | 7/m ² |
| 8 Connect Channel Trim C4, fixed at c300 mm | as required | as required |
| 9 Connect Fixing Plate C4 | 0,7/m ² | 0,7/m ² |
| 10 Connect Anchor Screw C4 | 0,7/m ² | 0,7/m ² |
| 11 Connect Installation Screw C4 | 3,4/m Channel trim C4 | |
| 12 Hygiene Advance Technical Tile | as required | as required |
| 13 Joint sealant (not supplied by Ecophon) | as required | as required |
| 14 Connect Demo Clip 20 C4, (where access is needed) | as required | as required |
| 15 Connect Hygiene Advance Tape | as required | as required |
| Δ Min. overall depth of system: 150 mm | - | - |
| δ Min. demounting depth: 150 mm | - | - |

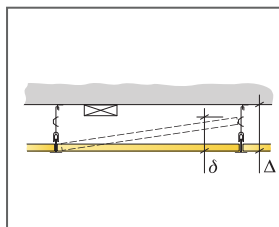

See Quantity Specification

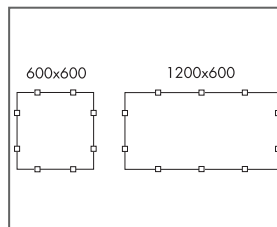

Arrangement of clips

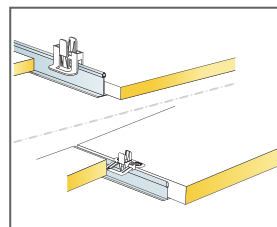

Clip for keeping tiles in place for 40 mm tiles

| Size, mm | Max live load [N] | Min load bearing capacity [N] |
|-------------|-------------------|-------------------------------|
| 600x600x20 | 40 | 160 |
| 600x600x40 | 40 | 160 |
| 1200x600x20 | 40 | 160 |
| 1200x600x40 | 40 | 160 |

Live load/load bearing capacity

INSTALLATION DIAGRAM (M252) FOR ECOPHON HYGIENE ADVANCE™ A C3

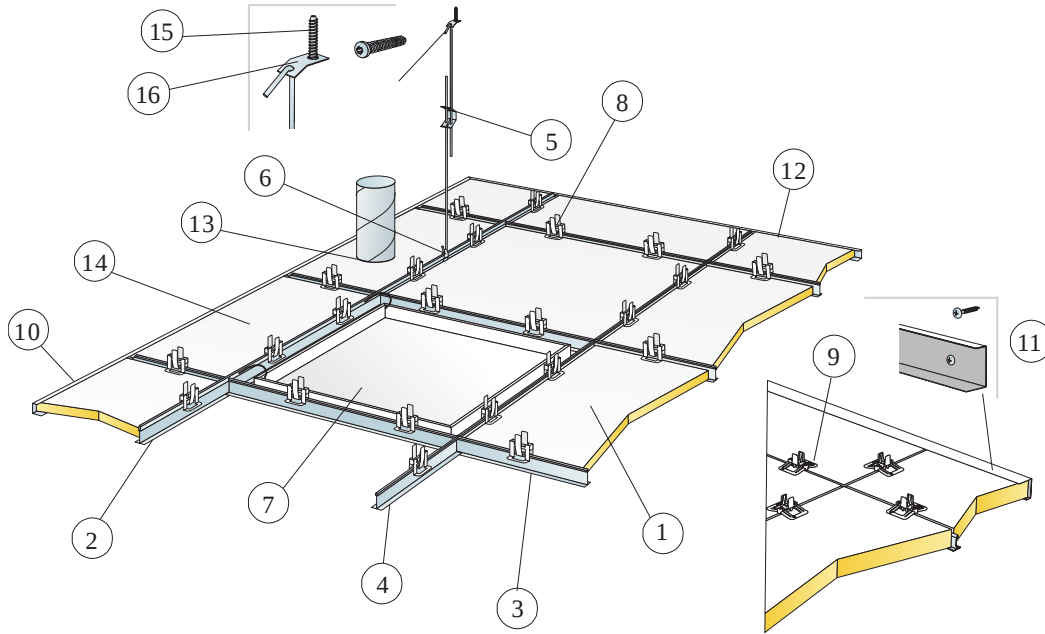

© Saint-Gobain Ecophon AB

QUANTITY SPECIFICATION (EXCL. WASTAGE)

| | Size, mm | |
|---|---------------------|---------------------|
| | 600x600 | 1200x600 |
| 1 Hygiene Advance A | 2,8/m ² | 1,4/m ² |
| 2 Connect T24 Main Runner C3, installed at 1200 mm centres | 0,9m/m ² | 0,9m/m ² |
| 3 Connect T24 Cross Tee C3, L=1200 mm, installed at 600 mm centres | 1,7m/m ² | 1,7m/m ² |
| 4 Connect T24 Cross Tee C3, L=600 mm | 0,9m/m ² | - |
| 5 Connect Adjustable Hanger C3, c1200 (max distance from wall 600 mm) | 0,7/m ² | 0,7/m ² |
| 6 Connect Hanger Clip (not to be used in swimming hall environments) | 0,7/m ² | 0,7/m ² |
| 7 Connect Inspection Hatch C3 | as required | as required |
| 8 Connect Hygiene Clip 20 | 11/m ² | 7/m ² |
| 9 Connect Hygiene Clip 40 | 11/m ² | 7/m ² |
| 10 Connect Channel Trim C3, fixed c300 (for 20 mm thickness) | as required | as required |
| 11 Connect Channel Trim C3, fixed c300 (for 40 mm thickness) | as required | as required |
| 12 Connect Hygiene Advance Tape | as required | as required |
| 13 Joint sealant (not supplied by Ecophon) | as required | as required |
| 14 Hygiene Advance Technical Tile | as required | as required |
| 15 Connect Anchor Screw C4 | 0,7/m ² | 0,7/m ² |
| 16 Connect Fixing Plate C4 | 0,7/m ² | 0,7/m ² |

Δ Min. overall depth of system: 150 mm

δ Min. demounting depth 20 mm: 150 mm

δ Min. demounting depth 40 mm: 170 mm

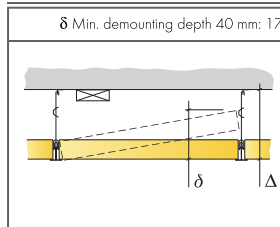

See Quantity Specification

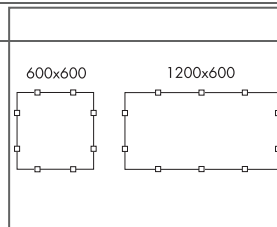

Arrangement of clips

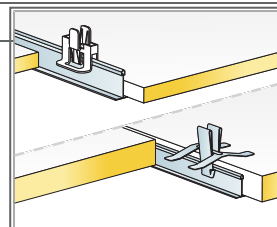

Clips for keeping tiles in place

| Size, mm | Max live load [N] | Min load bearing capacity [N] |
|-------------|-------------------|-------------------------------|
| 600x600x20 | 40 | 160 |
| 600x600x40 | 40 | 160 |
| 1200x600x20 | 40 | 160 |
| 1200x600x40 | 40 | 160 |

Live load/load bearing capacity

Ecophon Hygiene Advance™ Baffle

Ecophon Hygiene Advance™ Baffle is a vertical baffle that withstands daily advanced cleaning and disinfection with strong chemicals. Suitable for the most demanding conditions, including airborne grease and dirt particles.

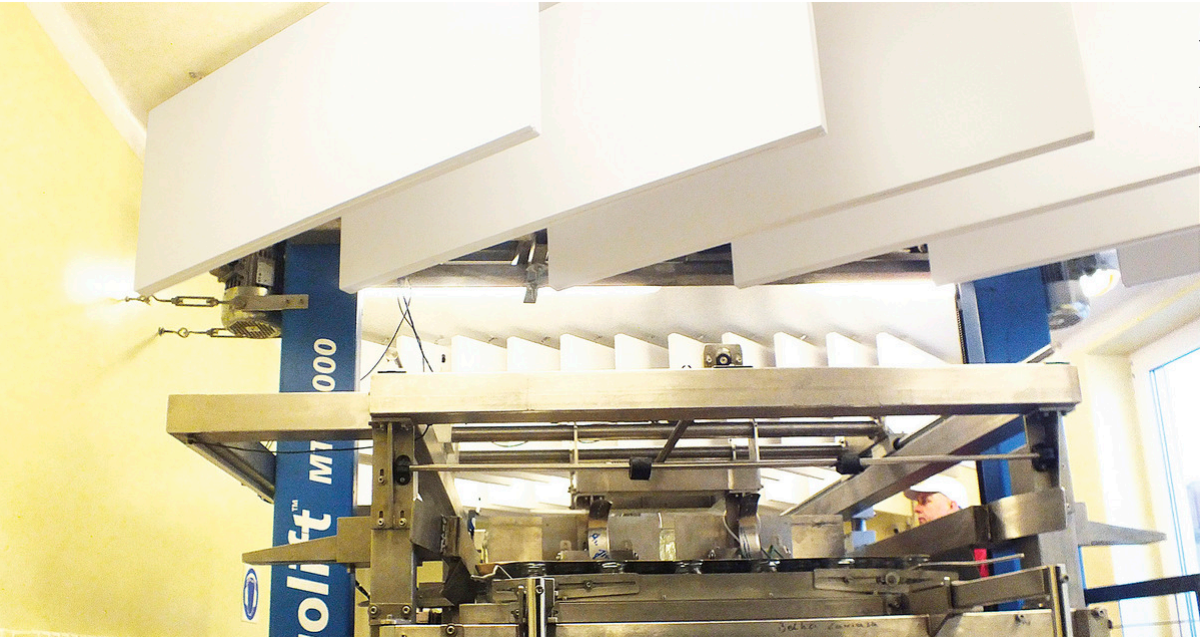

Kępczyn Małonezy, Poland

SYSTEM RANGE



| | |
|-----------------|------------|
| Size, mm | 1200x600 |
| T24 | • |
| Thickness (THK) | 40 |
| Inst. Diagr. | M259, M260 |

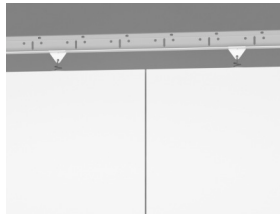

Hygiene Advance Baffle C3 in rows

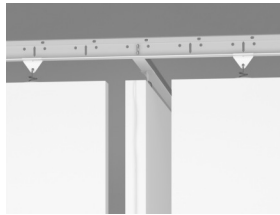

Hygiene Advance Baffle C3 in rectangles

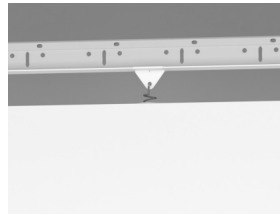

Hygiene Advance Baffle C3 with Connect Baffle clip



Hygiene Advance Baffle

Acoustic



Sound Absorption:

Test results according to EN ISO 354:2003 NOTE: Results shown are not comparable with results according to older versions of this standard due to discrepancies in test method. Classification according to EN ISO 11654, and the single value ratings for Noise Reduction Coefficient, NRC and Sound Absorption Average, SAA according to ASTM C 423.

α_p , Practical sound absorption coefficient

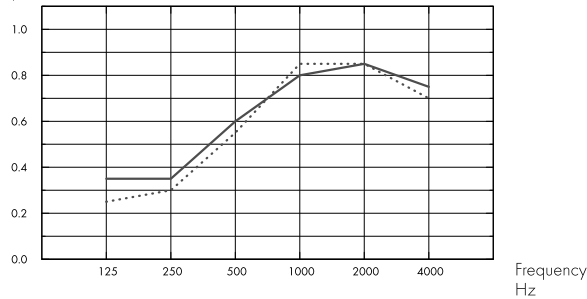

... Advance Baffle in rows, c600 mm, with ~1,4 baffles/m² ceiling area, 600 mm o.d.s.

– Advance Baffle in rectangles, with ~1,3 baffles/m² ceiling area, 600 mm o.d.s.

o.d.s = overall depth of system

| | THK mm | o.d.s. mm | α_p , Practical sound absorption coefficient | | | | | α_w | Sound absorption class | |
|---------------|--------|-----------|---|--------|--------|---------|---------|------------|------------------------|---------|
| | | | 125 Hz | 250 Hz | 500 Hz | 1000 Hz | 2000 Hz | | | 4000 Hz |
| in rows | 40 | 600 | 0.25 | 0.30 | 0.55 | 0.85 | 0.85 | 0.70 | 0.55 | D |
| in rectangles | 40 | 600 | 0.35 | 0.35 | 0.60 | 0.80 | 0.85 | 0.75 | 0.60 | C |

| | THK mm | o.d.s. mm | NRC | SAA |
|---------------|--------|-----------|------|------|
| in rows | 40 | 600 | 1.00 | 1.00 |
| in rectangles | 40 | 600 | 1.00 | 1.00 |

Indoor Air Quality



| Certificate / Label | |
|------------------------------|----------|
| Eurofins Indoor Air Comfort® | IAC Gold |
| French VOC | A+ |
| Finnish M1 | • |



Carbon footprint



| | kg CO ₂ equiv/m ² |
|----------------|---|
| Advance Baffle | 16,23 |

Life-cycle stages A1 to C4 from EPD, in conformity with ISO 14025 / EN 15804



Circularity

| | |
|--|------------------|
| Minimum post-consumer recycled content | 64% |
| Recyclability | Fully recyclable |



Fire safety

| Country | Fire standard | Class |
|---------|---------------|----------|
| Europe | EN 13501-1 | A2-s1,d0 |

The glass wool core of the tiles is tested and classified as non-combustible according to EN ISO 1182.



Humidity Resistance

Class C, relative humidity 95% and 30°C, according to EN 13964:2014



Visual appearance

White 141, nearest NCS colour sample S 1000-N, 73% light reflectance.



Cleanability

| Standard/Method | Frequency |
|--------------------------|-----------|
| Dusting | Daily |
| Wet wiping | Daily |
| Steam cleaning | Daily |
| Low pressure cleaning | Daily |
| High pressure cleaning | Daily |
| Hydrogen peroxide vapor | • |
| UV-C, BIFMA HCF 8.1-2019 | • |



Chemical resistance/Disinfection

| Chemical | Concentration |
|---------------------|---------------|
| Formalin | 37% |
| Ammoniac | 25% |
| Hydrogen peroxide | 30% |
| Sulfuric acid | 5% |
| Phosphoric acid | 30% |
| Peracetic acid | 15% |
| Hydrochloric acid | 5% |
| Isopropanol | 100% |
| Sodium hydroxide | 5% |
| Sodium hypochlorite | 5% |

Tested according to ISO 2812-1 and classified according to ISO 4628-1 with excellent result for the following chemicals.



Mould and Bacterial Resistance

| Standard/Method | Class |
|-----------------|-------|
|-----------------|-------|



Clean Room

| | Standard/Method | Class |
|-------------|-------------------------------|-----------|
| ISO 14644 | Particle cleanliness class | ISO 3 |
| NF S 90-351 | Microbiological class | M1/area 4 |
| NF S 90-351 | Particle elimination kinetics | CP(0,5) 1 |



Accessibility

The tiles are demountable.



Installation

Installed according to installation diagrams, installation guides and drawing aid. Cut tiles must be sealed with Connect Hygiene Advance Tape. Penetrations must be sealed with a suitable sealant.



System weight

The weight of the system (including suspension grid) should be approximately 4 kg/m².



Mechanical properties

See table about Max live load and Min load bearing capacity and Functional demands, Mechanical properties at www.ecophon.com.



CE

Ecophon ceiling systems are CE marked according to the European harmonized standard EN13964:2014. CE marked construction products are covered by a Declaration of Performance (DOP) which enables customers and users to easily compare performance of products available on the European market.

| | |
|--|------------------------------------|
| ISO 846 :2019 method C (for bacterium) | 0 (No growth under the microscope) |
| ASTM D3273-16 (for fungi) | 10 (0% growth on the surface) |

INSTALLATION DIAGRAM (M259) FOR ECOPHON HYGIENE ADVANCE™ Baffle C3 (IN ROWS)

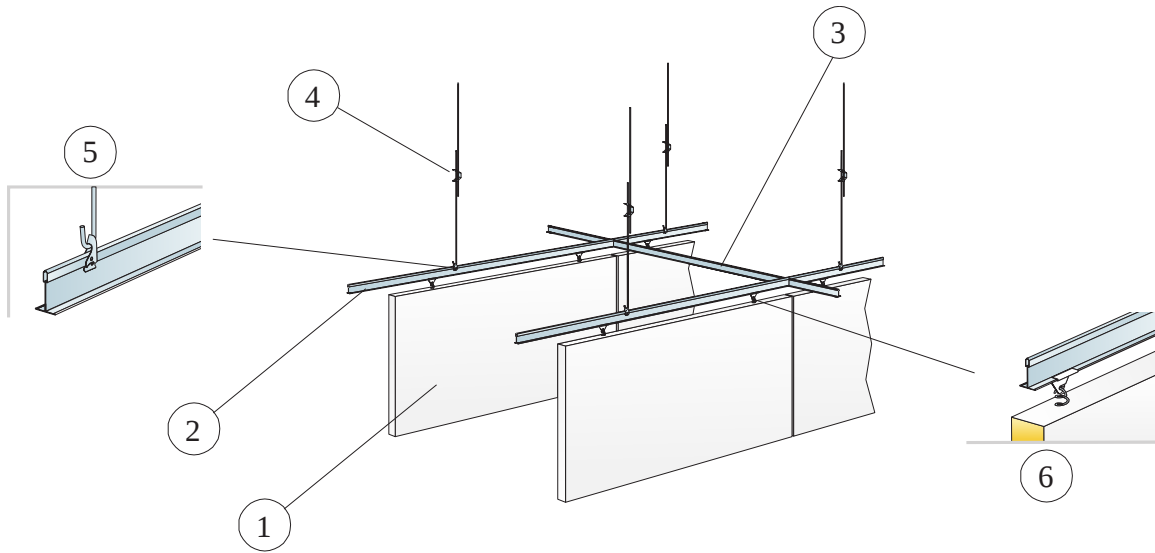

© Saint-Gobain Ecophon AB

QUANTITY SPECIFICATION (EXCL. WASTAGE)

| | | Size, mm |
|---|--|---------------------|
| | | 1200x600 |
| 1 | Hygiene Advance Baffle | 1,4/m ² |
| 2 | Connect T24 Main Runner C3, installed at 600 mm centres | 1,7m/m ² |
| 3 | Connect T24 Cross Tee C3, L=600 mm, installed at 1800 mm centres | 0,6m/m ² |
| 4 | Connect Adjustable Hanger C3 c1200 | 1,4/m ² |
| 5 | Connect Hanger Clip | 1,4/m ² |
| 6 | Connect Baffle Clip C3 | 2,8/m ² |

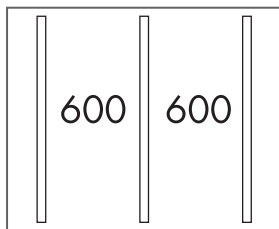

Installation in rows

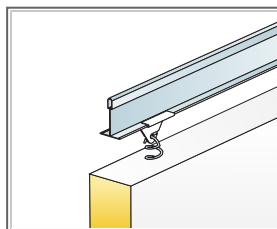

Detail of suspension

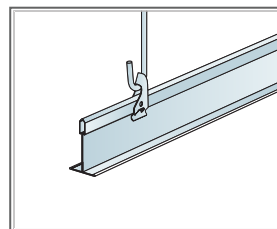

Suspension with Connect Adjustable Hanger and Connect Hanger Clip

| Size, mm | Max live load [N] | Min load bearing capacity [N] |
|-------------|-------------------|-------------------------------|
| 1200x600x40 | 0 | 160 |

Live load/load bearing capacity

INSTALLATION DIAGRAM (M260) FOR ECOPHON HYGIENE ADVANCE™ BAFFLE C3 (IN RECTANGLES)

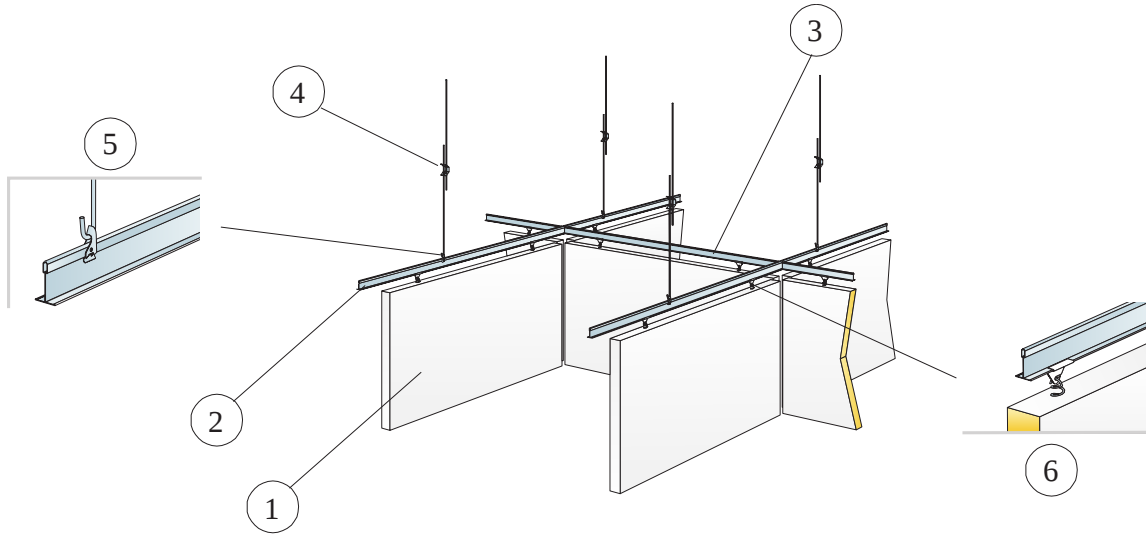

© Saint-Gobain Ecophon AB

QUANTITY SPECIFICATION (EXCL. WASTAGE)

| | | Size, mm |
|---|---|---------------------|
| | | 1200x600 |
| 1 | Hygiene Advance Baffle | 1,3/m ² |
| 2 | Connect T24 Main Runner C3, installed at 1250 mm centres | 0,8m/m ² |
| 3 | Connect T24 Cross Tee C3, l=1250 mm, installed at 1300 mm centres | 0,8m/m ² |
| 4 | Connect Adjustable Hanger C3 | 0,7/m ² |
| 5 | Connect Hanger Clip | 0,7/m ² |
| 6 | Connect Baffle Clip C3 | 2,5/m ² |

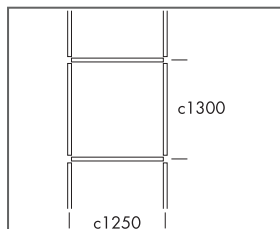

Installation in rectangles

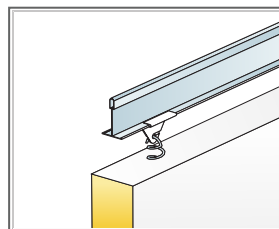

Detail of suspension

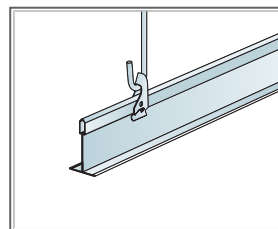

Suspension with Connect Adjustable Hanger and Connect Hanger Clip

| Size, mm | Max live load [N] | Min load bearing capacity [N] |
|-------------|-------------------|-------------------------------|
| 1200x600x40 | 0 | 160 |

Live load/load bearing capacity

Ecophon Hygiene Advance™ Wall

Ecophon Hygiene Advance™ Wall is a wall panel that withstands daily advanced cleaning and disinfection with strong chemicals. Suitable for the most demanding conditions, including airborne grease and dirt particles.



Easyfood, Kolding, Denmark

SYSTEM RANGE

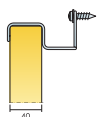

| | |
|-----------------|----------|
| Size, mm | 1200x600 |
| Special Fixing | • |
| Thickness (THK) | 40 |
| Inst. Diag. | M258 |



Hygiene Advance Wall



Connect Wall fixing C3



Hygiene Advance Wall C3 system

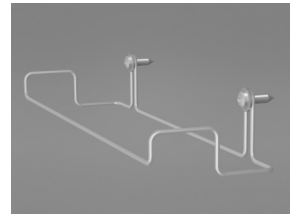

Connect Wall Fixing C3

Acoustic



Sound Absorption:

Test results according to EN ISO 354. Classification according to EN ISO 11654.

α_p , Practical sound absorption coefficient

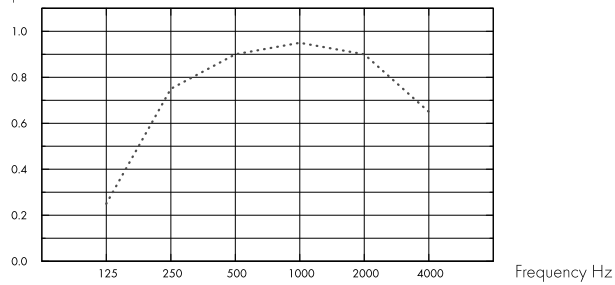

... Hygiene Advance Wall, 80 mm o.d.s.

o.d.s = overall depth of system

| THK mm | o.d.s. mm | α_p , Practical sound absorption coefficient | | | | | | α_w | Sound absorption class |
|-----------|-----------|---|--------|--------|---------|---------|---------|------------|------------------------|
| | | 125 Hz | 250 Hz | 500 Hz | 1000 Hz | 2000 Hz | 4000 Hz | | |
| 40 | 80 | 0.25 | 0.75 | 0.90 | 0.95 | 0.90 | 0.65 | 0.85 | B |

Indoor Air Quality



| Certificate / Label | |
|------------------------------|----------|
| Eurofins Indoor Air Comfort® | IAC Gold |
| French VOC | A+ |
| Finnish M1 | • |



Carbon footprint



| | kg CO ₂ equiv/m ² | Life-cycle stages A1 to C4 from EPD, in conformity with ISO 14025 / EN 15804 |
|--------------|---|--|
| Advance Wall | 16,23 | |

Circularity



| | |
|--|------------------|
| Minimum post-consumer recycled content | 64% |
| Recyclability | Fully recyclable |

Fire safety



| Country | Fire standard | Class |
|---------|---------------|----------|
| Europe | EN 13501-1 | A2-s1,d0 |

The glass wool core of the tiles is tested and classified as non-combustible according to EN ISO 1182.



Humidity Resistance

Class C, relative humidity 95% and 30°C, according to EN 13964:2014



Visual appearance

White 141, nearest NCS colour sample S 1000-N, 73% light reflectance.



Cleanability

| Standard/Method | Frequency |
|--------------------------|-----------|
| Dusting | Daily |
| Wet wiping | Daily |
| Steam cleaning | Daily |
| Low pressure cleaning | Daily |
| High pressure cleaning | Daily |
| Hydrogen peroxide vapor | • |
| UV-C, BIFMA HCF 8.1-2019 | • |



Chemical resistance/Disinfection

| Chemical | Concentration |
|---------------------|---------------|
| Formalin | 37% |
| Ammoniac | 25% |
| Hydrogen peroxide | 30% |
| Sulfuric acid | 5% |
| Phosphoric acid | 30% |
| Peracetic acid | 15% |
| Hydrochloric acid | 5% |
| Isopropanol | 100% |
| Sodium hydroxide | 5% |
| Sodium hypochlorite | 5% |

Tested according to ISO 2812-1 and classified according to ISO 4628-1 with excellent result for the following chemicals.



Mould and Bacterial Resistance

| Standard/Method | Class |
|--|------------------------------------|
| ISO 846 :2019 method C (for bacterium) | 0 (No growth under the microscope) |
| ASTM D3273-16 (for fungi) | 10 (0% growth on the surface) |



Clean Room

| | Standard/Method | Class |
|-------------|-------------------------------|-----------|
| ISO 14644 | Particle cleanliness class | ISO 3 |
| NF S 90-351 | Microbiological class | M1/area 4 |
| NF S 90-351 | Particle elimination kinetics | CP(0,5) 1 |



Accessibility

The tiles are demountable.



Installation

Installed according to installation diagrams, installation guides and drawing aid. For information regarding minimum overall depth of system see quantity specification.



System weight

The weight of the system (including profile system) should be approximately 3 kg/pcs.



Mechanical properties

See table about Max live load and Min load bearing capacity and Functional demands, Mechanical properties at www.ecophon.com.



CE

Ecophon ceiling systems are CE marked according to the European harmonized standard EN13964:2014. CE marked construction products are covered by a Declaration of Performance (DOP) which enables customers and users to easily compare performance of products available on the European market.

INSTALLATION DIAGRAM (M258) FOR ECOPHON HYGIENE ADVANCE™ WALL C3

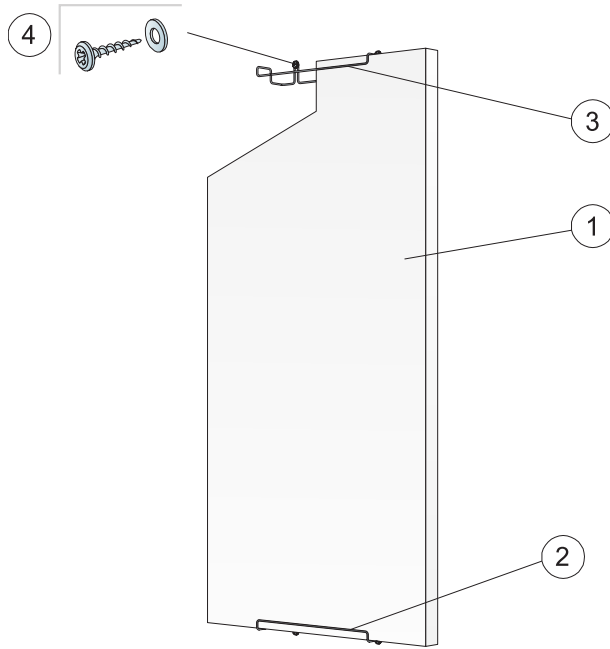

© Saint-Gobain Ecophon AB

QUANTITY SPECIFICATION (EXCL. WASTAGE)

| | | Size, mm |
|---------------------------------------|---|--------------------|
| | | 1200x600 |
| 1 | Hygiene Advance Wall | 1,4/m ² |
| 2 | Connect Wall Fixing C3, vertical installation | 2/panel |
| 3 | Connect Wall Fixing C3, horizontal installation | 4/panel |
| 4 | Wall screw, A2 material (not supplied by Ecophon) | 2/wall fixing |
| Δ Min. overall depth of system: 90 mm | | - |

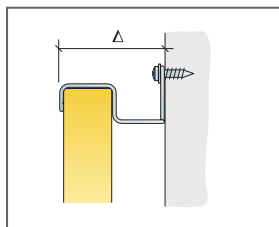

See Quantity Specification

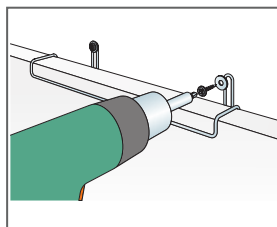

Installation with wall screw in stainless steel (A2) material

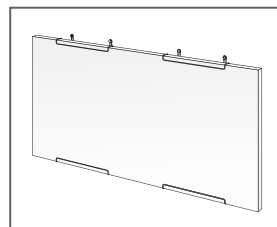

Horizontal installation of Advance Wall C3

| Size, mm | Max live load [N] | Min load bearing capacity [N] |
|-------------|-------------------|-------------------------------|
| 1200x600x40 | 0 | - |

Live load/load bearing capacity